

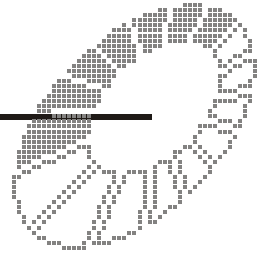

BARRETT 2090

HF MANPACK TRANSCEIVER



Operating and Installation Manual

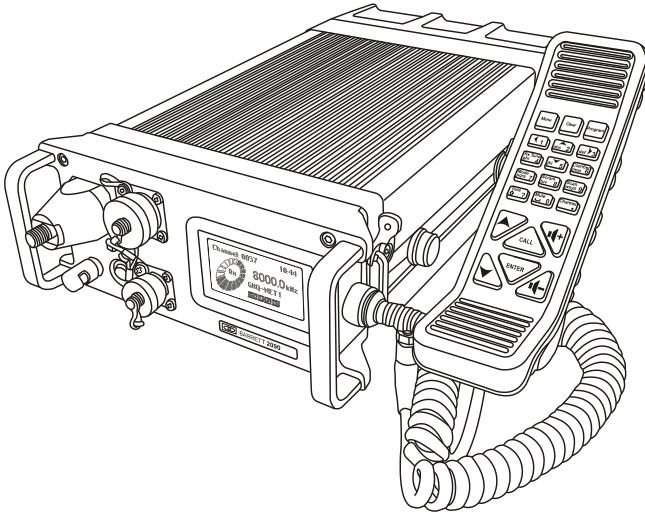

BCM20900/04

© Barrett Communications

Head Office:

Barrett Communications Pty Ltd
47 Discovery Drive, Bibra Lake, WA 6163 Australia
Tel: +61 8 9434 1700 Fax: +61 8 9418 6757
Email: information@barrettcommunications.com.au

www.barrettcommunications.com.au

Barrett 2090 Compliance	8
FCC RF Exposure Compliance Statement	8
FCC RF Exposure Warning	9
FCC Modulation Modes	9
Industry Canada Modulation Modes	9
About this Operating and Installation Manual	10
Icons and Standards	10
Scroll keys	10
Abbreviations and Acronyms	10
Introduction.....	12
Operation.....	13
User Controls.....	13
2090 Front Panel Description.....	13
Using the Handset.....	14
Keypad	16
Locking and Unlocking the Keypad.....	18
2090 Transceiver Rear Panel Description	20
Switching on the Transceiver	21
Switching on the Transceiver – Without a PIN.....	21
Switching on the Transceiver – With a PIN.....	21
Switching Off the Transceiver	21
Display.....	22
Receive Mode	22
Transmit Mode	23
Secure Mode.....	24
Channel Attributes.....	25
Adjusting the Audio Volume	26
Selecting a Channel	26
Using Channel Up/Down Keys.....	26
Direct Channel Number Entry	27
Barrett Selective Calling System	28
General	28
International	28
OEM 1	28
CCIR	28
ALE FED STD 188 / MIL STD 188-141B (option).....	28
Selective Call –“Selcall”	29
Selective Call “Telcall”	29
Special Notes When Using OEM 1 Selective Call Protocol	29
More Selective Calling Information	30
Selcall Self IDs	30
Selcall Decode	30
Selcall Transmit.....	30
Default Self IDs	31
Setting Default Self IDs.....	31
Detaching an ID From the Default Self IDs.....	32
Contacting Another Station - Using Selective Call “Selcall” and Telcall.....	34
Entering Station IDs and Using the Address and Telephone Books.....	34
When Asked to Enter a Station ID:-	34

Changing Self IDs During a Call	36
When Asked to Enter a Telephone Number:-	39
Checking for the Best Channel to Use Between Two Stations - Beacon Call.....	40
Sending a Beacon Call	40
Receiving a Beacon Call	41
Sending a Selcall	41
Receiving a Selcall	42
Receiving a Selcall Directed to Your Transceiver	42
Receiving All Calls, Group Calls and Sub-group Calls	43
“All call”	44
“Group call”	44
“Sub-group call”	44
Emergency Calls	45
Receiving an Emergency Call	45
Direct Dial Telephone Calls - Telcalls	46
Making a Direct Dial Telephone Call - Sending a Telcall.....	46
Last Number Redial	47
Hang Up Call.....	48
Preset/Predialled (Abbreviated Number) Telephone Calls	49
Preset (Abbreviated) Selcall Numbering.....	50
Fixed and Preset Address Book Entries	51
Fixed Address Book Entry	51
Preset Address Book Entry.....	52
Call History	53
Erasing Calls From History	53
Scanning Channels	55
Selcall Scan	55
Signal Strength Scan (SSL Scan).....	55
Voice (Syllabic) Scan	55
Selecting a Scan Table	56
Initiating Scan.....	56
Clarifier	57
Noise Reduction Selection	58
Mute (Squelch) Selection.....	59
Mode Selection	60
Tune	60
Advanced Selective Call Functions.....	61
Requesting Another Station’s GPS Position	61
Sending Your GPS Position to Another Station	63
Text Messaging – “Pagecall”, “SMS”	65
Sending a “Pagecall” “SMS”	65
Receiving a “Pagecall” “SMS”	67
Special Characters in a Pagecall	68
Remote Station Operational Status – “Statcall”	70
Requesting Another Stations Status	70
Person to Person(s) Secure Call.....	72
Tuning the Receiver	73
Scanning With the Tunable Receiver	74
Setting up Scan Frequencies	74
Start Receiver Scanning	75
Menu Functions	76
Menus	76

Standard Menu	77
Identification	77
Display Options	79
Backlight Level	79
Backlight Timeout	80
Call History	81
New Call	81
Inbox	81
Outbox	82
Address Books	84
Selcall ID Book – Add a New Entry	84
Selcall ID Book – Edit an Entry	87
Selcall ID Book – Erase an Entry	89
Phone Book - Add a New Entry	91
Phone Book - Edit an Entry	93
Phone Book - Erasing an Entry	95
ALE Autofill Book	97
ALE Autofill Book – Reassign an Entry	98
ALE Autofill Book – Erase an Entry	100
Audio Scrambler	101
To Enable Scrambled Mode	102
To Disable Scrambled Mode	102
Antenna Select	103
Protected Menu	104
General	104
Microphone Up/Down Keys	104
Transmit “Over Beep”	105
Transmit Timeout	106
Channel Labels	107
Edit Labels	107
Delete a Label	108
Add an Entry	109
Setting the Clock	110
Setting the Date	111
B.I.T.E. Test	112
Option Installation	113
Secure Call Code	114
Security Level	115
Upload Pack	116
Internal Modem	117
Scan Tables	119
Adding Channels to a Scan Table	119
Editing Channels in a Scan Table	120
Erasing Entries in a Scan Table	121
Changing Scan Table Labels	123
Scan Settings	125
Scan Rate	125
Scan Dwell	126
Scan Resume Time.....	127
Scan Table Select	128
Mute Settings	129
Syllabic Mute Sensitivity	129
Signal Strength Mute Level	130

Selcall Settings	131
Self IDs.....	131
Adding Self IDs	131
Modifying Self IDs	133
Deleting Self IDs	135
Selcall INT 1 – Setting Default International 4 Digit Selcall Self ID	137
Selcall INT 2 – Setting Default International 6 Digit Selcall Self ID	137
Selcall OEM 1 – Setting Default OEM 4 Digit Selcall Self ID	137
Selcall OEM 2 – Setting Default OEM 6 Digit Selcall Self ID	138
Selcall Alarm	139
Selcall Transmit Tones Audio Level	140
Selcall Pre-amble Length Setting	141
TXCVR Lock	142
OEM Privacy key.....	144
Audio Settings	145
Audio Bandwidth	145
“Beep” Volume Level.....	146
Receiver Audio Path Configuration	147
Transmitter Audio Path Configuration	148
Line Audio	149
Noise Reduction.....	150
RF Settings	151
Optional IF Filter Enable	151
Receiver Pre-amplifier.....	152
Clarifier Range	153
Noise Blanker Threshold	154
AGC Hang	155
I/O Settings	156
RS-232 Out	156
External Alarm.....	157
Antenna type	158
GPS Receiver Enable	160
Line Output Level Adjust	161
Line Input Level Adjust.....	162
Automatic Link Establishment (ALE) (Option)	163
ALE System Overview	163
Operation Overview	163
To Commence Scanning.....	164
Linking to Another Station in an ALE Network	165
Making a Netcall.....	168
Sending an ALE Text Message to Another Station in an ALE Network	171
Telephone Call to ALE Stations with Telephone Interconnect Facilities	176
Selecting ALE Station IDs	180
Receiving an ALE Call	181
Receiving an ALE Message	184
Receiving an ALE Telephone Call	186
Receiving an ALE Netcall	188
Closing Individual ALE links	190
Closing all ALE Links	192
Remote Station Closes the ALE Link	193
Combined ALE / Selective Call Capability	194
Overview	194

To Commence Scanning.....	194
Transmitting an ALE Call	195
Receiving an ALE Call	195
Receiving and Transmitting a Selective Call (Selcall).....	195
ALE Configuration Menus	196
ALE State	196
ALE Autofill.....	197
ALE Scan List.....	198
Auto Transmit.....	199
Transmit Control.....	200
Sounding Control	201
Sounding Address.....	202
Link Quality Analysis (LQA) Exchange	203
Link Quality Analysis (LQA) Exchange Mode	204
Link Quality Analysis (LQA) Averaging	205
Link Quality Analysis (LQA) Decay Rate.....	206
Threshold Test	207
SINAD Threshold	208
BER Threshold	209
ALE Fill Mode.....	210
Programming Functions	211
Programming Using the Programming Software.....	211
Programming Using the Supplied Barrett Cable	211
Programming a Channel from the Front Panel.....	212
Transmit and Receive Frequencies	212
Channel Use Labels.....	213
Operating Mode	213
Transmitter Power Setting.....	214
Selcall Format	214
Cloning (Programming) from Another Transceiver	216
Manpack Operation	218
Power Systems	218
Charging a 10Ah Lithium Ion Battery Cartridge Outside the Manpack	221
Battery Charge Indicator when Charging the 2090	224
Operation in the Manpack Configuration	225
Using the Display / Handset Extender Interface (P/N BCA209013).....	225
Manpack Operation Using the Automatic Antenna Tuner.....	227
Using the Collapsible 3 m Whip (P/N 2090-02-07)	227
Using the Emergency Long Wire Antenna (P/N 2090-02-06)	228
Using the Counterpoise Earth Kit - multi-wire (P/N 2090-02-08)	229
Operation of the 2090 Manpack in Temporary Base Stations	230
Rapid Deployment Broadband Dipole Antenna - 40 W (2090-02-03).....	230
Rapid Deployment Broadband Dipole Antenna Configurations	231
Horizontal Dipole.....	231
Inverted V.....	231
Sloping Dipole.....	232
Inverted U	232
Rapid Deployment Dipole Antenna - 40 W (2090-02-01).....	233
Rapid Deployment Dipole Antenna Configurations.....	234
Horizontal Dipole.....	234

Inverted V.....	234
Sloping Dipole.....	235
Single Ended.....	235
Connectors.....	236
Auxiliary Socket	236
ESU/CW Socket	237
Handset Socket	238
Power Socket (on Battery Pack)	239
GPS Receiver/Antenna Module P/N 2090-01-22.....	240
Overview of HF Operation	241
HF Propagation.....	241
Radio Wave Propagation Illustrated	242
Day.....	242
Night.....	243
Factors Which Affect HF/SSB Communications	243
Frequency Selection	243
Time of Day.....	244
Weather Conditions.....	244
Man-made Electrical Interference	244
System Configuration and Installation.....	244
Special Note - HF Communications Compared with VHF or UHF Short Distance Communications	244
Limited 3 Year Warranty	245
Warranty Registration and Customer Support.....	246

Barrett 2090 Compliance**Barrett 2000 series transceivers comply to the following communications standards:-**

Australian / New Zealand Standard

MF and HF radio communications

Equipment in the land mobile service utilising single sideband suppressed carrier emission

AS/NZS 4770:2000

FCC Part 90

Barrett 2000 series transceivers comply to the following EMC standard:-

EN301 489-1 V 1.4.1 (2002-08)

Barrett 2000 series transceivers comply to the following electrical safety standard:-

EN60950-1:2002

FCC RF Exposure Compliance Statement

The Barrett 2090 HF Transceiver has been tested and complies with the Federal Communications Commission (FCC) RF exposure limits for the General Population/Uncontrolled exposure environment.

In addition, it complies with the following Standards and Guidelines:

FCC 96-326, Guidelines for Evaluating the Environmental Effects of Radio-Frequency Radiation

FCC OET Bulletin 65 Edition 01-01 (2001) Supplement C, Evaluating Compliance with FCC

Guidelines for Human Exposure to Radio Frequency Electromagnetic Fields

ANSI/IEEE C95.1-1992, IEEE Standard for Safety Levels with Respect to Human Exposure to Radio Frequency Electromagnetic Fields, 3 kHz to 300 GHz

ANSI/IEEE C95.3-1992, IEEE Recommended Practice for the Measurement of Potentially Hazardous Electromagnetic Fields - RF and Microwave

FCC RF Exposure Warning

To ensure optimal transceiver performance and to avoid exposure to excessive electromagnetic fields, the antenna system must be installed according to the instructions provided.

High voltages exist on the antenna during transmission and tuning. Do not touch the antenna during these activities. RF burns may result.

Install the grounding system or counterpoise as directed to prevent RF burns from any metal part of the transceiver.

Safe working distance is based on continuous exposure to CW type transmissions, as set out in the ICNIRP Exposure Guidelines (1998) for occupational exposure. Safe working distance can be reduced with normal voice communication.



For FCC compliance, when the 2090 transceiver is used at a power level of 125 watts PEP, the antenna(s) used with this transceiver should be located at least 3 metres from the operator and should not be co-located or operating in conjunction with any other antenna or transmitter.



For FCC compliance, when the 2090 transceiver is used at a power level of 30 watts PEP, the antenna(s) used with this transceiver should be located at least 1.5 metres from the operator and should not be co-located or operating in conjunction with any other antenna or transmitter.

FCC Modulation Modes

Please note that J3E Upper Sideband Mode is the only modulation mode available for operation in the United States of America.

Industry Canada Modulation Modes

Please note that J3E Upper Sideband Mode is the only modulation mode available for operation in Canada.

About this Operating and Installation Manual

This manual is comprehensive, describing all aspects of the transceivers functions and should be viewed as a reference manual.

A separate abbreviated Quick Reference Guide card with primary functions is also supplied with each transceiver and should be kept at the operating position of the transceiver.

Icons and Standards

Scroll keys

This manual refers to Scroll keys these keys are:-



to scroll Up



to scroll Left



to scroll Down



to scroll Right

Abbreviations and Acronyms

This term...	Means....
ALE	Automatic Link Establishment
Call history	A list containing details of the last thirty calls you have received
Station ID	The ID of the station being called (the receiving station's self ID)
GPS	Global Positioning System
HF	High Frequency
Identification Code	The unique reference identification (ID) of your transceiver (not serial number)
LCD	Liquid Crystal Display
LSB	Lower Sideband (Not available in FCC)

USB	Upper Sideband
PCB	Printed Circuit Board
PIN	Personal Identification Number
PSTN	Public Switched Telephone Network
PTT button	Press-to-talk button
RDD	Radio Direct Dial
Receive only channel	A channel that allows you to receive calls but not transmit calls
Revertive signal	An acknowledgement signal automatically transmitted from a station receiving a Selcall
RF	Radio Frequency
Rx	Receive
Scan Table incoming	A list of channels used when scanning for calls
Selcall	Selective Calls
Telcall protocol	Telephone calls via the Selective Call
Self ID	The programmed address identification number of your station. (Used by other stations to call you).
SSB	Single Sideband (a transmission format)
Transmit channel	A channel that allows you to receive and transmit calls
Tx	Transmit
USB	Upper Sideband

Introduction

The Barrett 2090 man pack is a DSP based, 500 channel HF SSB transceiver with a frequency range of 1.6 to 30 MHz. The Barrett 2090 is designed using the latest technology enabling a physically small package with a full feature complement.

Designed to operate in the most arduous environments encountered in remote operational areas, the 2090 will provide many years of efficient and trouble free service.

The 2090 supports features such as Selective Call (Selcall), direct dial telephone connection to base stations fitted with telephone interconnect systems (Telcall), GPS location) These features make the 2090 one of the most economical and versatile HF transceivers available today.

The 2090 has catered for the increased use of HF data transmission for Internet email access and point to point data applications, by providing a comprehensive data modem interface port, high speed transmit to receive switching, a high stability frequency standard and an efficient cooling system option.

All 500 channels are available to be field or workshop programmable. Auxiliary features such as Selcall, Telcall, scanning, mute status, alarm system etc. can be individually enabled or disabled for every channel as required to suit your operation.

Teamed with other matching Barrett 2000 series products which include antennas, vehicle tracking packages, HF-VHF/UHF crosspatches and HF modems, the 2090 becomes a powerful tool, providing solutions to most long distance communication requirements.

Operation

User Controls

2090 Front Panel Description

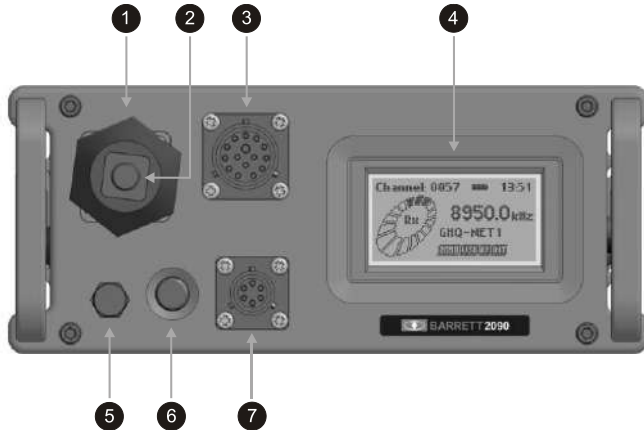

- ① 50 ohms antenna socket under whip adaptor
- ② Whip and long wire adaptor - when using automatic antenna tuner**
- ③ Accessory interface connector – for external modems, programming etc.
- ④ Removable display module – removable to wear on webbing
- ⑤ Earth post – for counterpoise connection
- ⑥ Power On / Off button
- ⑦ ESU,GPS, CW key connector

**** Note:-** When using whip or long wire select “Whip or long wire” in the standard menu area “Antenna Type”

Using the Handset

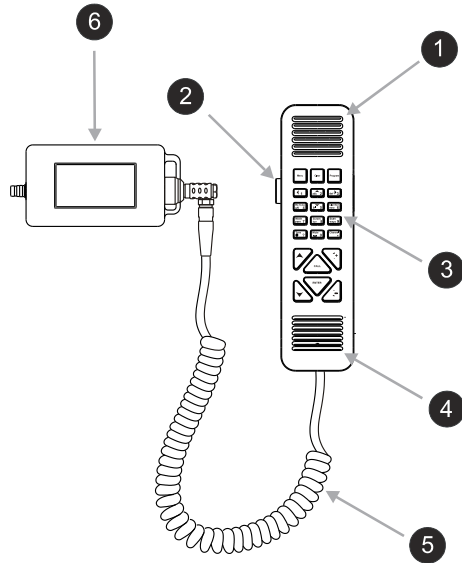

- ① Earphone
- ② Transmit (PTT) button.
- ③ Keypad- with touch backlighting
- ④ Microphone
- ⑤ Handset to LCD unit interface cable
- ⑥ Detachable LCD unit

The handset combines a transmit PTT button, earpiece, microphone and operator keypad.

When Using the Handset:-

Press and hold down the PTT (transmit) button only while talking

Hold the microphone close to your mouth

Speak clearly









Use the word 'over' to indicate you have finished speaking and release the PTT (transmit) button.













Note:- the 2090 has a transmit "time-out" facility. This facility (when programmed) allows the transmitter to be keyed in transmit mode with the PTT (transmit) switch for a set time period, after which the transceiver switches to receive until the PTT (transmit button is released and re-keyed. This facility prevents the transmitter transmitting for long periods of time if, for instance, the microphone becomes jammed between seats in a vehicle causing the PTT (transmit) switch to be held down.

Note:- Enabling, disabling and changing the time of the transmit timeout facility can be set either when programming the transceiver or in the "General" section of the protected menu.

Keypad

There are 21 keys on the keypad. A group of five keys in the centre access many major functions. Some keys have multiple functions assigned to them depending on when the key is pressed and for how long the key is pressed. Key functions are listed below followed by a detailed description of their functions.

Key	Key Primary function	Secondary function
	Channel up	General scroll key
	Channel down	General scroll key
	Volume up	None
	Volume down	None
	Make a call	None
	Enter	Lock / Unlock Keypad
	Enter menus	None
	Transmitter tune mode	Change case HELP
	Enter clarifier tune mode	Alpha "mno" Numeric key "6"

Key	Key Primary function	Secondary function
	Clear back one step	None
	Enter direct channel change mode	Decimal point
	Enter tuning receiver Mode	Alpha "ghi" Numeric key "4"
	Turn scrambler on / off	Alpha "tuv" Numeric key "8"
	Enter program mode	None
	Mute (squelch) selection	Alpha "space" Numeric key "0"
	Mode select USB, LSB, AM, CW, AFSK	Alpha "pqrs" Numeric key "7"
	Start scan, hold for 2 seconds for scan table selection	Alpha "wxyz" Numeric key "9"
	Scroll left	Numeric key "1"
	Scroll up	Alpha "abc" Numeric key "2"
	Scroll right	Alpha "def" Numeric key "3"
	Scroll down	Alpha "jkl" Numeric key "5"

Locking and Unlocking the Keypad

The keypad can be locked by the user to stop accidental key press activity.

To lock the keypad press and hold down the  key. The display will show the following :



Once the  key has been held down long enough the “Keypad Locked” message will be displayed.



The “Keypad Locked” message will be shown whenever a key is pressed.

To unlock the keypad press and hold down the  key. The display will show the following :





Once the key has been held down long enough the "Keypad Unlocked" message will be displayed./



The keypad will automatically unlock when a Selcall or ALE call is received.

2090 Transceiver Rear Panel Description

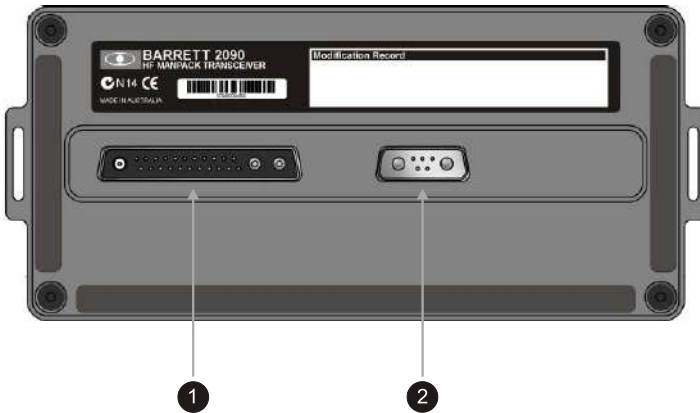

The rear panel connectors mate with either the battery or the vehicle docking station.

- 1 Multiway Accessory and Docking station power connector
- 2 Battery Power Connector

Switching on the Transceiver

Switching on the Transceiver – Without a PIN

Pressing the power on/off button (please refer to “2090 front panel description” section) turns transceiver on.

Switching on the Transceiver – With a PIN

Press the power on/off button to turn the transceiver on.

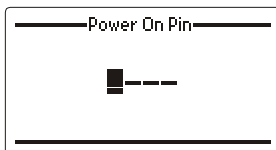

Enter the PIN and press **ENTER** key

The transceiver will now be switched on, if however the incorrect PIN was entered the following is displayed:-



This display will time out and allow the re-entry of the PIN. If however the PIN is entered 10 times incorrectly the transceiver will not allow PIN entry for a period of one hour displaying the following:-

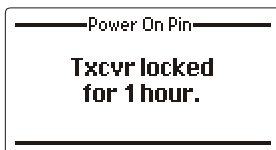

Note:- The power on PIN would have been loaded into the transceiver during programming if the function is in use. Refer to your network administrator.

Switching Off the Transceiver

Press the power on/off button to turn the transceiver off.

Display

Receive Mode

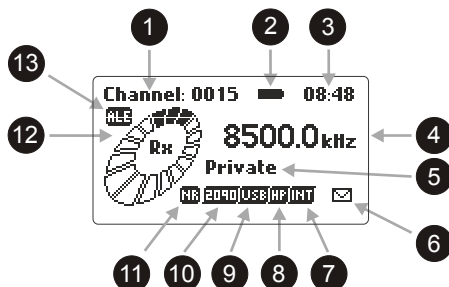

In receive mode the LCD display shows:-

- | | |
|-----------------------------------|-------------------------------------|
| 1 Channel number | 8 Power setting |
| 2 Battery level | 9 Mode |
| 3 Time | 10 2090 Icon |
| 4 Receive frequency. | 11 Noise reduction activated |
| 5 Channel use | 12 Receive signal strength |
| 6 Missed Selcalls received | 13 ALE Active |
| 7 Selective Call mode. | |

Transmit Mode

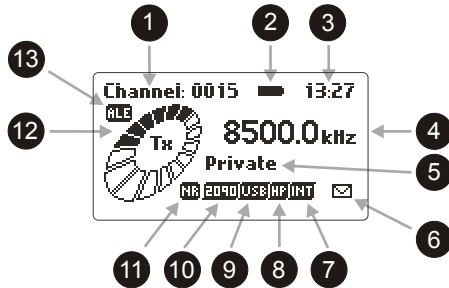

In transmit mode the LCD display shows:-

- | | | | |
|---|--------------------------|---|---------------------------|
| ① | Channel number | ⑧ | Power setting |
| ② | Battery level | ⑨ | Mode |
| ③ | Time | ⑩ | 2090 Icon |
| ④ | Transmit frequency. | ⑪ | Noise reduction activated |
| ⑤ | Channel use | ⑫ | Transmit power |
| ⑥ | Missed Selcalls received | ⑬ | ALE Active |
| ⑦ | Selective Call mode. | | |

Secure Mode

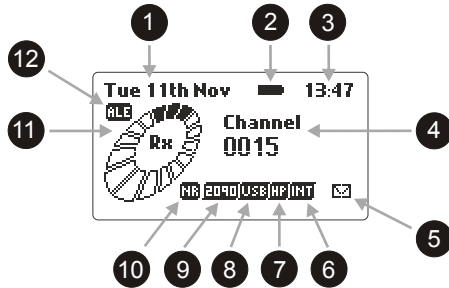

In secure mode the LCD display shows:-

- | | | | |
|---|--------------------------|---|---|
| ① | Date | ⑦ | Power setting |
| ② | Battery level | ⑧ | Mode |
| ③ | Time | ⑨ | 2090 Icon |
| ④ | Channel number. | ⑩ | Noise reduction activated |
| ⑤ | Missed Selcalls received | ⑪ | Receive signal strength /
Transmit Power |
| ⑥ | Selective Call mode. | ⑫ | ALE active |

Channel Attributes

Pressing and holding down the  key for more than 2 seconds will reveal more details about the currently selected channel:-



Using the **Scroll keys** to scroll down will reveal further details:-

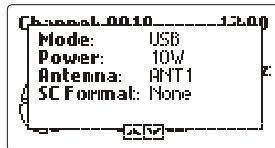

Note:- when in Secure mode the channel attributes do not show frequencies.

Adjusting the Audio Volume



To increase the audio volume in the loudspeaker



To decrease the audio volume in the loudspeaker

The display looks like this when adjusting the volume:-



Selecting a Channel

Using Channel Up/Down Keys

Pressing the channel up or down key will select respectively the next higher or lower programmed channel. Holding down either of the keys will cause the rate of the channel change to increase.

The channel up/down keys on the microphone have the same function as the channel up/down keys on the keypad.



Channel up



Channel down

Note:- The microphone up/down buttons needs to be configured for channel change function either when programming the transceiver or in the “**General**” section of the protected menu.

Direct Channel Number Entry

press the  key

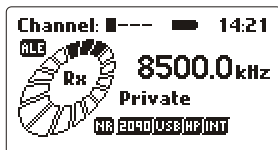

Enter the channel number required, using the numeric keys, channel range is from 1 to 9999 inclusive. Note:- **Channel zero cannot be selected.** (example selects channel 12)

press the    keys



press the  key



If the channel selected had not been previously programmed then the following is displayed:-



Note: Empty channels can only be accessed by direct channel selection and are not displayed when scrolling through channels.

Barrett Selective Calling System

General

In addition to the use of the transceiver in simple voice mode to call other stations there are several different types of Selective Calling systems available.

The calling systems available for the Barrett 2090 transceiver are listed below:-

International

A four and six digit Selective Call system, fully interoperable with the UN format published in September 2004 and fully backwards compatible with all previous Barrett 4 digit Selcall protocols.

Includes Selcall, Beacon Call, Pagecall (SMS) call, transceiver lock call and RFDS tone calls.

Also if the options are fitted to the transceiver it includes:-

GPS calls, used to either transmit your position to another station or request the position of another station fitted with the GPS option and receiver.

Telcalls for direct dial telephone number calling using base stations with telephone interconnect facilities.

Person to person Secure Calls

OEM 1

A four and six digit Selective Call system compatible with other major HF manufacturers including those using encryption. Includes Selcall, Telcall, Beacon Call, Pagecall and GPS call.

CCIR

A four digit Selective Call system as specified by CCIR-493.

Includes Selcall, Beacon Call and tone calls.

Also, if the option is fitted to the transceiver, Telcalls for direct dial telephone number calling using base stations with telephone interconnect facilities.

ALE FED STD 188 / MIL STD 188-141B (option)

MIL-STD Automatic Link Establishment system, see section "Automatic Link Establishment"

Selective Call –“Selcall”

Selcall is a digital signalling system based on standard CCIR-493 for use on HF networks. Each station in an HF network can be assigned up to 10 self IDs of which there can be a mixture of four or six digit IDs (identification). The station can be called using any of these self IDs.

Selective Call “Telcall”

Telcall uses this digital Selective Call system to transport a telephone number from a station on an HF network to a base station equipped with a telephone interconnect unit to initiate phone calls onto the international telephone network.

Note:- For Selcall and Telcall functions to operate the transceiver must be fitted with the Selcall or Telcall option and the channels enabled for Selcall operation.

If **Automatic Link establishment (ALE)** is in use refer to the ALE section for operation details.

Special Notes When Using OEM 1 Selective Call Protocol

All 6 digit OEM 1 protocol calls will only be decoded by other Barrett transceivers fitted with OEM 1 Selcall protocol or other manufacturers' transceivers using encryption.

OEM 1 protocol 4 digit calls will be decoded by Barrett 950 transceivers, Barrett 2090 transceivers using International 4 and 6 digit Selcall and other manufactures transceivers with similar CCIR 493 based Selective Call systems.

4 & 6 digit GPS and Status data calls use the OEM privacy key to encrypt the data. If this 8 digit key has not been programmed by the programming software a default privacy key of "99999999" is automatically used for transmission.

6 digit Pagecalls also use the privacy key but unlike the other calls the user has the option to manually enable or disable the privacy key. When disabled the data is sent as plain text. See "OEM Pagecall Key" in the protected menu "Selcall settings" section, to switch the privacy key "On" or "Off" when sending Pagecalls.

More Selective Calling Information

Selcall Self IDs

As from software version 2.00 the 2050 transceiver can have up to 10 selcall self IDs assigned to it. These Selcall IDs can be any combination of 4 or 6 digit OEM or International type id.

Selcall Decode

As from software version 2.00 the 2050 transceiver has the ability to decode both OEM and International Selcalls on any channel programmed as a Selcall channel. Calls for each format type will only be decoded if there is at least one self id of that format programmed into the transceiver self id group.

Selcall Transmit

Selcall formats in transmit are channel specific, only call types programmed for the channel are permitted. This means International and CCIR format calls can only be sent on channels that are programmed as International or CCIR selcall channels, OEM calls can only be sent on channels that are programmed as OEM selcall channels.

Default Self IDs

Default self IDs are the IDs used when making a selective call. They are used when the self ID is not set during the call procedure or the Selcall address book entry being used does not have a self ID attached to it. These IDs are also used when making calls via the RS232 control command set.

Setting Default Self IDs

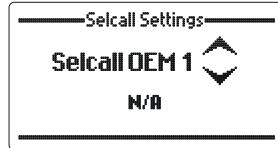

then press the  key.



Use the scroll keys to select the self id to attach to the default ID (in this case the 4 digit OEM default ID)

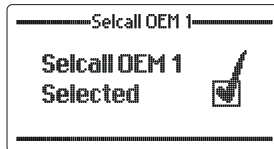

then press the  key.
Repeat the steps above for each default ID.

Detaching an ID From the Default Self IDs

Detaching an ID from the default IDs will force the operator to select a self ID when making a Selcall.

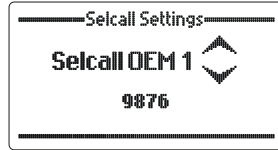

then press the  key.



press the  key until the "Detach Self ID?) screen appears.

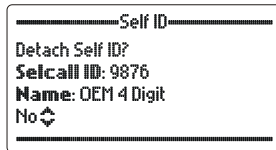

Use the scroll keys to select the option required.

Self ID
Detach Self ID?
Selcall ID: 9876
Name: OEM 4 Digit
Yes ↕



then press the key.

Selcall OEM 1
Entry
Detached

Contacting Another Station - Using Selective Call "Selcall" and Telcall

Entering Station IDs and Using the Address and Telephone Books

Selcall and Telcall functions described in this section require station IDs or telephone numbers to be entered when making a call. They make use of convenient address and telephone books to allow frequently used Station IDs, station names and telephone numbers to be easily entered. This section describes how to enter station Selcall IDs and telephone numbers both manually and by using the address and telephone books.

Note:- also see section "Address and phone books – adding, editing and deleting entries"

When Asked to Enter a Station ID:-

Either enter the station ID using the numeric keys (the number of the station you wish to call, see "Station ID ranges")

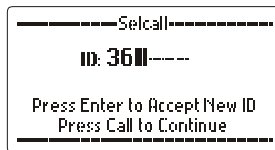

or if you think that station is in the address book use the **Scroll keys** to find the station you want to call:- .

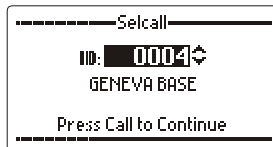

then press the  key



or if you know the name of the station press the  key and either enter the first letter of the name you want to call using the alpha keypad then use the **Scroll keys** or use the **Scroll keys** to find the name of the station you want to call (example "r" entered):-



then press the  key

or press the  key and the last station called will be called again.

Changing Self IDs During a Call

During any selective call process pressing the  button after the destination address has been entered will continue on with the call process. If the  button is pressed and held for 2 seconds then the option of changing the self ID of the call will become available. If the destination address is a fixed address entry then the operator cannot change self IDs during the call.

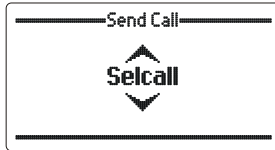

press the  key



Use the scroll keys to select the address required

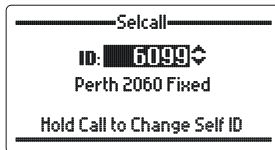

press and hold the  key for 2 seconds



this address book entry ID is fixed so the self ID cannot be changed.



Use the scroll keys to scroll to a non fixed address book entry.

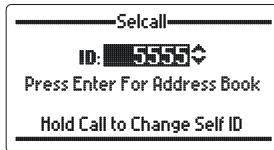

press and hold the  key for 2 seconds



Use the scroll keys to select the new self ID to be transmitted then press the  key to continue the call process.

Station ID ranges

4 and six digit networks are all accommodated in the 2090 standard Selcall system

Station ID range from 000000 to 999999 inclusive (the destination ID **must** be either 4 or 6 digits long)

Calling groups

In four digit format

All call A station sending X000 will be received by stations X000 - X999 (up to 890 stations*)

Group call A station sending XX00 will be received by stations XX00 - XX99 (up to 89 stations*)

Sub-group call A station sending XXX0 will be received by stations XXX0 - XXX9 (up to 9 stations*)

In six digit format

All call A station sending XXX000 will be received by stations XXX000 - XXX999 (up to 890 stations*)

Group call A station sending XXXX00 will be received by stations XXXX00 - XXXX99 (up to 89 stations*)

Sub-group call A station sending 0 will be received by stations 0 - 9 (up to 9 stations*)

* If using the group call system, stations cannot be programmed to have self IDs with last digits 000,00,0 as if you tried to call them a group call would occur.

Note:- All call, group call or sub-group call must be enabled, during programming, on a destination station for group calling to operate.

When Asked to Enter a Telephone Number:-

Either enter the telephone number using the numeric keypad (a number up to 16 digits)



or if you think that telephone number is in the phone book use the **Scroll keys** to find the name and number you want to call:-



or if you know the name associated with the telephone number in the phone book press the  key and either enter the first letter of the name you want to call using the alpha keypad and use the **Scroll keys** or use the **Scroll keys** to find the name you want to call:-



or press the  key and the last phone number called will be called again.

Checking for the Best Channel to Use Between Two Stations - Beacon Call

Before using many of the Selcall and Telcall functions in this section it is useful to know how to use the "Beacon Call" function.

"Beacon Call" allows the operator to determine the signal quality between their station and a station they want to call on a particular channel, but without actually alerting the station they are doing so.

When a Beacon Call is sent to another station, if the channel being used is "open", the remote station sends back a distinctive 4 tone reverberate signal. The operator can judge the quality of the channel for communications purposes by the strength and clarity of this distinctive tone. Using Beacon Calls on several available channels will determine which channel is best to use subsequent Selcalls or Telcalls

(Note:- both stations must be programmed for Selcall or Telcall operation)

Sending a Beacon Call

select the channel you think will be best to use (Refer to section Overview of HF operation)

listen for traffic on that channel, if no traffic is heard then continue.

then press the  key

select "Beacon Call" with the scroll keys



then press the  key

enter the station ID of the station you wish to Beacon Call (see "Entering station IDs and using the address and telephone books")

then press the  key

wait for the Beacon Call to be sent.

listen for the distinctive 4 tone reverberate signal from the station you have called.

If no reverberate call is heard or it was difficult to hear try another channel and repeat the process until the best channel is found.

Receiving a Beacon Call

When a transceiver receives a beacon request call, it responds by transmitting the Beacon Call reverte tones. No indications occur on the transceiver. Beacon Calls are **not** saved in the Selcall history buffer.

Sending a Selcall

select the channel you want to send the Selcall on. ("Beacon Call" can be used to select the best channel)

listen for traffic on that channel, if no traffic is heard then continue

then press the  key

select "Selcall" with the scroll keys

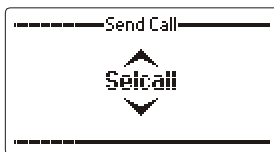

then press the  key

enter the station ID of the station you wish to call (see "**Entering station IDs and using the address and telephone books**")

then press the  key

wait for the Selective Call to be sent.

listen for reverte tone from the called station that indicates the call was successful.

If no reverte tone is heard or it was difficult to hear try another channel and repeat the process until a good channel is found.

If a reverte tone is heard but you receive no verbal response from the station it may be because the operator is unavailable at the time.

Receiving a Selcall

To receive a Selcall your transceiver must be programmed for Selective Call (Selcall) and where multiple channels are in use the scan function should be activated.

Receiving a Selcall Directed to Your Transceiver

When you receive a Selcall, your station sends a revertive call (to alert the calling station that its call was received), an audible alarm is sounded, the mute (squelch) (if selected) opens and the display shows the call as follows:-



The audible alarm will sound for thirty seconds and then time out. To cancel the alarm before the time out period and to acknowledge the call, press PTT or any key. When the audible alarm times out the call received “Envelope” icon is displayed in the bottom right hand side of the display and a periodic audio reminder will be emitted:-

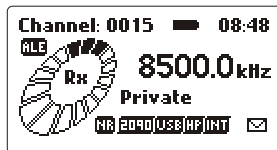

For details of previously received Selcalls enter “Call History” by holding the



key down for two seconds or more. Refer to the section “Call History”.

Receiving All Calls, Group Calls and Sub-group Calls

Stations can send a Selective Call that will alert different groupings of mobiles as follows:-

In four digit format

- All call** A station sending X000 will be received by stations X000 - X999 (up to 890 stations*)
- Group call** A station sending XX00 will be received by stations XX00 - XX99 (up to 89 stations*)
- Sub-group call** A station sending XXX0 will be received by stations XXX0 - XXX9 (up to 9 stations*)

In six digit format

- All call** A station sending XXX000 will be received by stations XXX000 - XXX999 (up to 890 stations*)
- Group call** A station sending XXXX00 will be received by stations XXXX00 - XXXX99 (up to 89 stations*)
- Sub-group call** A station sending 0 will be received by stations 0 - 9 (up to 9 stations*)

* If using the group call system, stations cannot be programmed to have self IDs with last digits 000,00,0 as if you tried to call them a group call would occur.

Note:- All call, group call or sub-group call must be enabled, during programming, on a destination station for group calling to operate

Receiving an “All call ” , “Group Call”, “Sub-Group Call”

When you receive any of the calls above an audible alarm is sounded, the mute (squelch) (if selected) opens and the display shows the call type as follows:-

“All call”



“Group call”



“Sub-group call”



In all group calls the audible alarm will sound for thirty seconds and then time out. To cancel the alarm before the time out and to acknowledge the call press PTT or any key. When the audible alarm times out the call received “envelope” icon is displayed in the bottom right hand side of the display:-

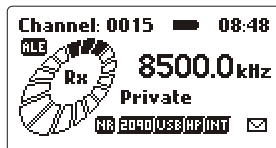

For details of previously received Sencalls enter “Call History” by holding the



key down for two seconds or more. Refer to the section “Call History”.

Emergency Calls

Receiving an Emergency Call

Barrett transceivers that receive an emergency Selcall emit a distinctive audio alarm and display the following:-



If the transceiver sending the emergency Selcall is fitted with a GPS receiver the position will also be displayed as illustrated below :-

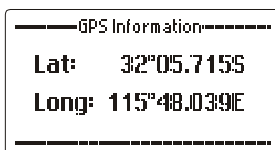

If the transceiver sending the emergency Selcall was not fitted with GPS or no data is available the following is displayed:-



Direct Dial Telephone Calls - Telcalls

Transceivers equipped with the Telcall option can direct dial telephone numbers and receive calls from telephone users through a Barrett telephone interconnect base stations.

Note:- If ALE is in use refer to the ALE section for details.

Making a Direct Dial Telephone Call - Sending a Telcall

select the channel you want to send the Telcall on. ("Beacon Call" can be used to select the best channel)

listen for traffic on that channel, if no traffic is heard then continue.

press the  key

select "Telcall" with the scroll keys

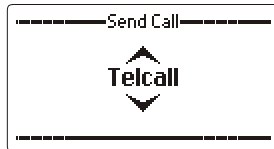

then press the  key

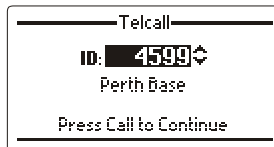

enter the station ID of the station you wish to make the phone call through (see "Entering station IDs and using the address and telephone books")

then press the  key



enter the telephone number you want to call (see **“Entering station IDs and using the address and telephone books”**)

then press the  key

wait for the Telcall to be sent.

listen for revertive tone from the called station that indicates the call was successful.

If no revertive call is heard try another channel and repeat the process.

When the call is successful wait for telephone connection to be made and proceed with call..

When the call is complete or if the line is busy send a “Hang Up” call.

Last Number Redial

press the  key twice

the last telephone number sent will is displayed:-



then press the  key and the Telcall sequence will be re-sent.

Hang Up Call

When a call to a telephone interconnect base station has been completed the caller should **"hang up"** by sending a "hang up" code:-

press the  key

select "Hang up" with the scroll keys



then press the  key



select the ID of the telephone interconnect that you are connected through

then press the  key

When the hang up Selcall has completed transmitting, listen for hang up revertive signal, confirming the "hang up" was successful, if not heard repeat the above procedure.

Note:- If the hang up call is unsuccessful for any reason the telephone interconnect will time out and hang up itself.

Preset/Predialled (Abbreviated Number) Telephone Calls

A base station equipped with telephone interconnect facilities is also capable of making preset (abbreviated number) telephone calls, these calls are also known as predialled calls. Preset (abbreviated) telephone numbers are stored in the telephone interconnect unit and are accessed by sending a standard Selcall using a specific Selcall number.

select the channel you want to send the "hang up" call on.
("Beacon Call" can be used to select the best channel)

listen for traffic on that channel, if no traffic is heard then continue

press the  key

select "Selcall" with the scroll keys

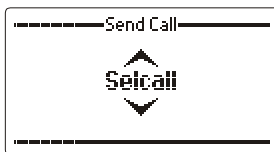

enter the Selcall number representing the preset (abbreviated number as described below - Preset (abbreviated) Selcall numbering:-

then press the  key

wait for the Selective Call to be sent.

listen for revertive tone from the called station that indicates the call was successful.

If no revertive call is heard or it was difficult to hear try another channel and repeat the process until a good channel is found.

Preset (Abbreviated) Selcall Numbering

Enter xxxxAA or xxAA where xxxx or xx is the (four) six or (two) four digit Selcall ID of the base station equipped with telephone interconnect facilities and AA represents the preset telephone number (between 1 and 98)

Example:-

Entering 4523 will instruct a telephone interconnected base station with a four digit Selcall ID of 45XX to call preset (abbreviated) number stored as 23 in the telephone interconnect.

Entering 342547 will instruct a telephone interconnected base station with a six digit Selcall ID of 3425XX to call preset (abbreviated) number stored as 47 in the telephone interconnect.

Note:-

When using preset (abbreviated) number dialling, your network supervisor will issue you with a list of the preset numbers and the phone numbers they will dial when using a particular telephone interconnected base station.

Fixed and Preset Address Book Entries

Fixed Address Book Entry

Address book entries can be programmed to be fixed to certain self IDs via the 2000 Series Programming Software. This stops the transceiver operator from being able to select which self ID is to be used when calling a specific address book entry. In other words the self ID attached to the address book entry will always be used and can only be changed via the 2000 Series Programming Software.

Making a Call to a Fixed Address Book Entry

press the  key



Use the scroll keys to select the address required



press the  key, if the address entry is a fixed entry then

holding down the  key will cause the following display to be shown.



Preset Address Book Entry

Preset or predialled address book entries are used when the destination transceiver is connected to a telephone interconnect which has preset facilities available. Preset address book entries are fixed and can only be changed via the 2000 Series Programming Software. This means that the operator only needs to know which preset number (01 to 98) has the required phone number set.

Making a Call to a Fixed Preset Address Book Entry

press the  key



use the scroll keys to select an address which has preset capabilities. This is shown when the last 2 digits of the destination station ID are shown as 'XX'. Then press the  key.

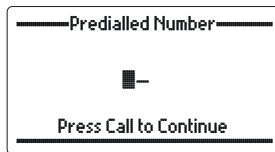

enter the 2 digit preset ID required.

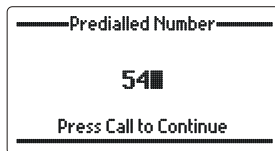

press the  key to send the call

Call History

Whenever a Selcall, Telcall, All call, Group call, Sub group call, Pagecall, Statcall GPS or Emergency call is received or transmitted its details are held in a first in first out call history buffer.

Received calls that have not been viewed before are held in a section called "New Calls", received calls that have been viewed are held for future viewing in the "Call inbox" all transmitted calls are stored in the "Call Outbox". Each history buffer can store up to 30 entries.

Call history can be entered as follows:-

Either

Press and hold the  key for 2 seconds:-



Or

Select Call history in the Standard Menu section

Note:- A full description of navigating the call history section is described in the Standard Menu section of this manual.

Erasing Calls From History

Individual or all entries can be deleted from the Outbox, Inbox or New Calls section of the Selcall history. Below is an example of how to delete an individual call from the Inbox of Selcall history.

Enter Selcall history as described above.

Go to the Inbox menu.

Use the scroll keys to select the call to be deleted then press and hold the key. The display will show the following:

Clear

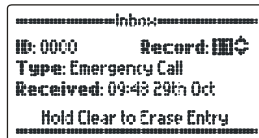

Hold the  key until the "Erase Entry" screen is shown.

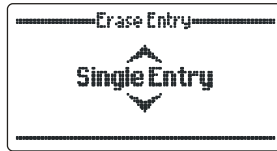

press the  key and the entry will be deleted.

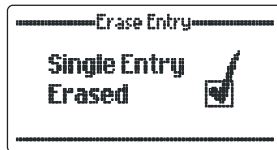

To delete all entries from a Selcall history section scroll to the "All Entries" screen then press the  key.



Scanning Channels

Scanning allows a HF transceiver to monitor several channels for incoming calls. It is particularly useful as the nature of HF signal propagation means that not all channels are available for communications at one time. For instance, a station calling a station that is in scanning can send a "Beacon Call" on any channel knowing the station it is calling is monitoring all its available channels. A response from the scanning station will only occur on channels that are "open" for communication.

Stations in scan can also monitor channels for voice activity or signals received that has a signal strength over a preset level.

Selcall Scan

When a Selcall signal is detected, and the channel has Selcall enabled, no matter which mute type is selected the transceiver will stop scanning and decode the Selcall. The transceiver will only stop scanning when a Selcall is detected.

Signal Strength Scan (SSL Scan)

If the signal strength mute (squelch) is active and a signal with a level greater than the pre-set threshold is received the scan will halt. Scan will remain halted while the signal level stays above the preset threshold. Once the signal decreases below the pre-set threshold level, for a period greater than the scan dwell period, scanning will resume.

Voice (Syllabic) Scan

If the audio mute (squelch) is active and is opened scanning will halt. Scanning will remain halted while the audio mute is open. Once the mute closes, for a period greater than the scan dwell period, scanning will resume.

The Barrett 2090 transceiver has up to eight scan tables available each table being able to be programmed with up to thirty channels. (See Menus and Programming for details on channel entry)

Selecting a Scan Table

press the  key for more than two seconds
use the scroll keys to select the scan table number



then press the  key

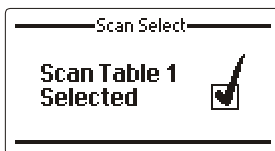

Note:- If no scan tables are programmed the following is displayed:-



Initiating Scan

Momentarily press the  key.

Alternatively scan may be programmed as a default condition so when the transceiver is switched on, scan is automatically initiated, or after a period of inactivity, i.e. no key presses, the transceiver returns to scan.

Clarifier

The clarifier is used to finely tune the receiver on the selected channel to compensate for received signals from other stations that are off frequency.

The receiver can be tuned in the clarifier mode in steps of 1 Hz to frequencies up to -1 kHz and +1 kHz of the assigned channel frequency, depending on programming. (see note below)



to enter clarifier tune mode.

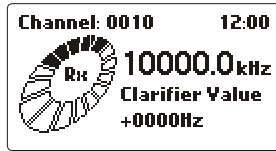

or



tune clarifier up



or



tune clarifier down

Note:- There are five clarifier ranges available, these ranges can be set either when programming the transceiver or in the “**RF Settings**” section of the protected menu.

Note:- The clarifier value is set to zero when the channel is changed or the transceiver is turned off.

Noise Reduction Selection

The DSP noise reduction system is enabled and disabled by momentarily pressing the  key.

When the noise reduction system is selected the display shows a small square to the right of the mode indication notated NR as below:-



The DSP noise reduction system is disabled by momentarily pressing the  key.

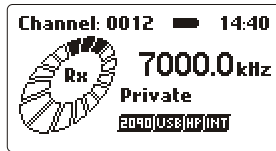

Note:- There are three levels of noise reduction available, these levels can be set either when programming the transceiver or in the “**Audio Settings**” section of the protected menu.

Mute (Squelch) Selection

There are three mute (squelch) modes:-

Audio (syllabic) Mute (Squelch) – the receiver audio is enabled when speech is detected on the selected channel.

Note:- The syllabic mute sensitivity can be set to three levels, these levels can be set either when programming the transceiver or in the “**Mute Settings**” section of the protected menu.

Selective Call Mute (Squelch) – the receiver audio is enabled after a Selcall sent to the unit has been received and decoded successfully

Signal Strength Level (SSL) Mute (Squelch) – the receiver audio is enabled when the received signal strength exceeds the nominated threshold level.

Note:- The signal strength mute level can be set to three levels, these levels can be set either when programming the transceiver or in the “**Mute Settings**” section of the protected menu.

The current mute (squelch) state is displayed the first time the mute key  is pressed.

To change the mute state, while the mute state is still displayed from the first press of the mute key, press the mute key again to scroll through to the required mute state.

Press the  key

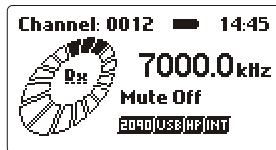

Press the  key



Mode Selection

The mode key changes the mode of operation - LSB, USB, AM, CW or AFSK of the selected channel. The mode key will only temporarily set the mode for a selected channel, the mode reverting to that channel's programmed mode after the channel is changed, or the transceiver is turned off.

Press the  key repeatedly to select the required mode:-

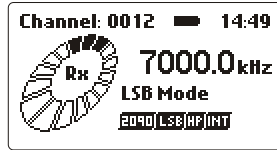

Note:- If the IF filter option is physically fitted and enabled in software, it will automatically be selected when CW and AFSK mode is selected.

Tune

Press and hold down the  key to tune:-



When tuning, the transceiver will transmit, at the power level selected, a carrier on the channel selected, at 1.6 kHz above the **Suppressed Carrier Frequency (SCF)** (displayed frequency) of that channel.

When the tune key is released the display shows the antenna VSWR.

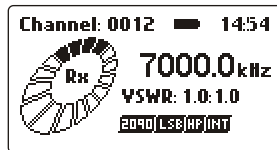

Advanced Selective Call Functions

Requesting Another Station's GPS Position

select the channel you want to send the GPS request call on.
 ("Beacon Call" can be used to select the best channel)

listen for traffic on that channel, if no traffic is heard then press the



key

select "GPS Request" with the scroll keys



then press the



key

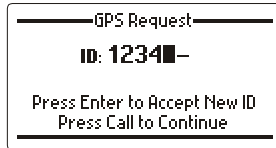

enter the identification of the station you want to request the GPS
 position from (see "Entering station IDs and using the address
 and telephone books")

then press the



key



Wait for the station you called to send back its position data after which the following will be displayed:-

The station called GPS position:-

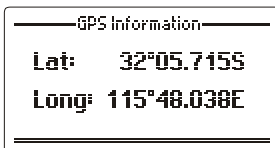

or – the following error messages:-

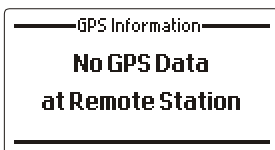

The GPS unit is not providing data to the remote transceiver



There is no GPS receiver fitted to the remote transceiver



There was no response from the remote station

Sending Your GPS Position to Another Station

select the channel you want to send the GPS call on. ("Beacon Call" can be used to select the best channel)

listen for traffic on that channel, if no traffic is heard then continue.

press the  key

select "GPS Send" with the scroll keys:-

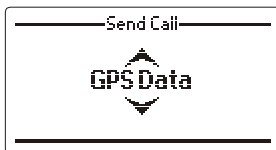

then press the  key

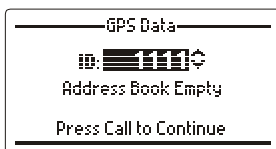

enter the identification of the station you want to send your GPS position to (see "Entering station IDs and using the address and telephone books")

then press the  key

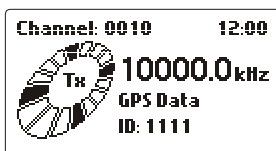

Your GPS position will now be transmitted, wait for a revertive tone from the remote station to confirm the call was received, if no revertive tone is heard repeat the process or change to another channel and repeat the process.

Note:- The GPS interface option P/N 2090-01-04 must be fitted and the GPS receiver P/N 2090-01-05 must be connected and receiving position information when using the GPS call option.

Note:- If the display indicates that the GPS is unavailable as shown below you cannot select the Selective Call function "GPS data."

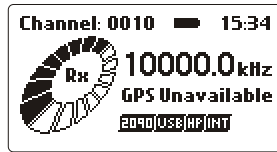

Text Messaging – “Pagecall”, “SMS”

Pagecall allows messages of up to 32 characters in International format or 64 characters in OEM format to be sent or received to and from other transceivers with Pagecall facilities.

Sending a “Pagecall” “SMS”

select the channel you want to send the Pagecall on. (“Beacon Call” can be used to select the best channel)

listen for traffic on that channel, if no traffic is heard then continue.

press the  key

select “Pagecall” with the scroll keys



then press the  key

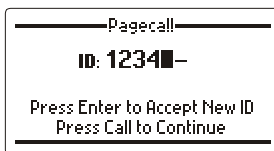



enter the identification of the station you want to send the Pagecall to (see “**Entering station IDs and using the address and telephone books**”)

then press the  key

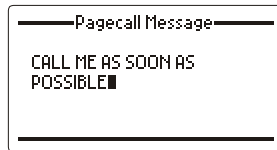

type in your messages using the alpha numeric keys



then press the  key



Receiving a “Pagecall” “SMS”

When a Pagecall is received an audible alarm is sounded, the mute (squellch) is opened and the display shows the following:-

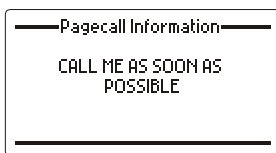

The audible alarm will sound for thirty seconds and then time out. To cancel the alarm before the time out period and to acknowledge the call, press PTT or any key.

When the audible alarm times out the call received “**Envelope**” icon is displayed in the bottom right hand side of the display.

For details of previously received Pagecalls enter “**Call History**” by holding the



key down for two seconds or more.

Special Characters in a Pagecall

As from V2.00 of transceiver firmware “Pagecall” selective call messages have the ability to send special characters out as part of the message. These special characters are ‘*’, ‘#’ and ‘.’. To get the new characters to display properly the transceiver front panel unit needs to be fitted with V14 or later firmware.

press the  key

select “Pagecall” with the scroll keys

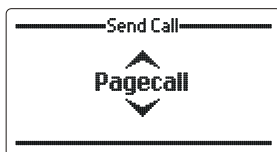

then press the  key

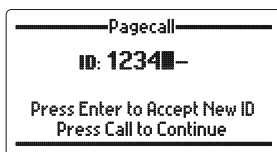

enter the identification of the station you want to send the Pagecall to (see “**Entering station IDs and using the address and telephone books**”)

then press the  key



To select a '.' character press the  key.





To select either the '*' or '#' character the transceiver needs to go into 'Special Character Mode'. To do this press the  key.



Please note that if V14 or later front panel firmware is not fitted then a '?' will be shown in place of the '#'.



Use the up/down scroll keys to select the character required. Pressing the  key again will exit the 'Special Characters Mode' without saving the character to the message.

To save the character to the message press the  or  keys.

Once the special character has been saved continue on with the Pagecall as per normal.

Remote Station Operational Status – “Statcall”

“Statcall” allows the operational status parameters of any Barrett transceiver fitted with Selcall to be accessed. This status is sent from the remote transceiver as a Selcall with the status information embedded within the Selcall structure. Information retrieved for remote diagnosis of transceiver performance includes:-

- Selcall ID
- Software version
- Option level fitted and transceiver model
- Receive state battery voltage
- Last transmit state battery voltage
- Signal strength indication of received status request Selcall.
- Forward power output level
- VSWR of antenna

Requesting Another Stations Status

select the channel you want to send the Status request call on. (“Beacon Call” can be used to select the best channel)

listen for traffic on that channel, if no traffic is heard then continue.

Then press the  key

select “Status Request” with the scroll keys

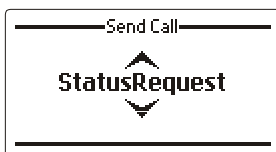

then press the  key



enter the identification of the station you want to request the operational status from (see “**Entering station IDs and using the address and telephone books**”)

then press the  key

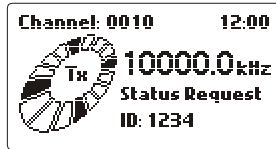

The status request is being transmitted



Your station is waiting for the station you called to send back its "Status data" (which sounds like the remote station sending a Selcall to you) after which the following will be displayed, use the

or keys to move through the pages:-

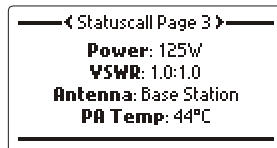
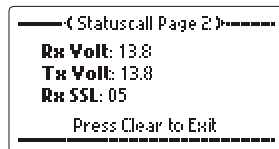
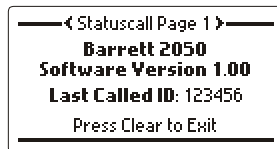

or – the following error messages:-



There was no response from the station you requested the status from, repeat the process or change the channel and repeat the process

Person to Person(s) Secure Call

This facility allows a secure voice connection to be made between two or more stations.

Note:- In the protected menu "Audio Setting" section, scrambler must be enabled in the "Scrambler section" and in the "Scrambler code" section a 4 digit number entered. For security purposes this code must be the same as the code set in the station you wish to call.

select the channel you want to set up the secure link on. ("Beacon Call" can be used to select the best channel)

listen for traffic on that channel, if no traffic is heard then continue.

press the  key

select "Secure Selcall" with the scroll keys



press the  key



enter the station ID of the station you wish to call (see "**Entering station IDs and using the address and telephone books**")

Note:- to make a Secure Call to multiple stations use a group call ID encompassing the required stations.

press the  key

wait for the Selective Call to be sent.

listen for revertive tone from the called station that indicates the call was successful.

If no revertive tone is heard or it was difficult to hear try another channel and repeat the process until a good channel is found. Revertive tones will not be heard if using a group call code to call multiple stations.

Tuning the Receiver

The 2090 transceiver can be used as a tunable receiver. The receiver can be tuned from 500 kHz to 30 MHz in steps ranging from 1 Hz up to 10 MHz.

Press the  key to enter the tuning receiver mode:-

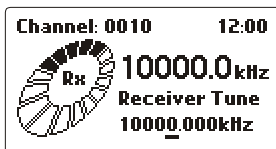

To tune the receiver move the cursor over the digit representing the frequency increment required in the receiver frequency display you wish

to tune using either the  or  keys, then use.



or



to tune up in frequency



or



to tune down in frequency

press the  key to return to the previous operating channel.

Scanning With the Tunable Receiver

The receiver can scan any range of frequencies from 500 kHz to 30 MHz with a frequency step down to 10 Hz.

Setting up Scan Frequencies

To set up the frequency scan parameters, enter the tuning receiver mode, then:-

Press the  key for two seconds until the following is displayed:-

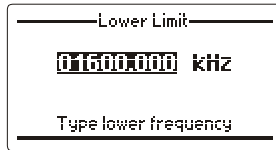

Enter a new frequency, using the numeric keys, to set the lower scan limit boundary - example below shows the lower limit set to 12 MHz:-

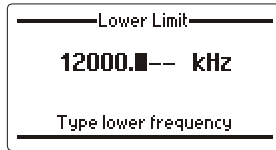

then press the  key

Enter a new frequency, using the numeric keys, to set the upper scan limit boundary - example below shows the upper limit set to 14 MHz:-

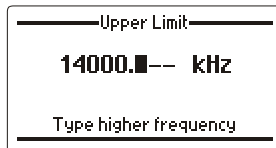

then press the  key



Using the Scroll keys select step increment required in Hz (Steps available 100 Hz (0.1 kHz), 250 Hz (0.25 kHz), 1000 Hz (1 kHz), 2500 Hz (2.5 kHz) (example shown 2500 Hz)

then press the  key



Using the Scroll keys select step speed in milliseconds. (steps available 100 mS, 250 mS, 500 mS, 1000 mS (example shown 250 mS)

then press the  key

Start Receiver Scanning

To start receiver scanning, enter the tuning receiver mode, then:-

press the  key

The receiver will now be scanning using the last entered parameters.

The receiver will now be scanning using the entered parameters.

The transceiver will halt scanning for the following reasons:-

Signal Strength Level (SSL) mute is selected and a signal with a level greater than the pre-set threshold is received.

Audio (syllabic) mute is selected and a voice signal is detected

Menu Functions

Menus

The menu is divided into two sections, the “Standard Menu” and the “Protected Menu”. Both sections are used to set or display transceiver parameters. The “Standard Menu” is available directly to operators as no critical operation parameters can be changed in this section.

The “Protected Menu” has some critical parameters and needs the operator to press the menu key for two seconds to enter it.

Note:- Menu items in both menus can be barred from use, if operationally required, by using Barrett 2050 PC based programming software.

Navigating the Menus

All sections of the Menus are operated using the similar key press sequences. In this section when describing the functions available in the Menu system it is assumed the operator is familiar with the following:-

press the  key to enter the “Standard Menu” section

press the  key **for more than 2 seconds** to enter the “Protected Menu” section

use the **Scroll keys** to select the menu item you require.

then press  key

Once in the menu item, again use the **Scroll keys** to select a parameter or enter a value using the numeric or alpha key.

When you have the parameter or value required press the



 key

Note:- Due to network operation requirements access to items in the Standard Menu or Protected Menu may be barred by network administrators during programming.

Standard Menu

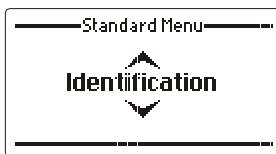
Identification



Use the  and  keys to scroll back and forth through the identification pages:-

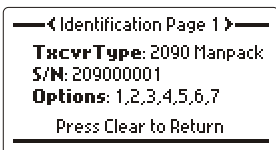

Shows transceiver type, transceiver serial number and transceiver options fitted.

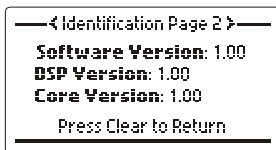

Shows all firmware versions fitted to transceiver.

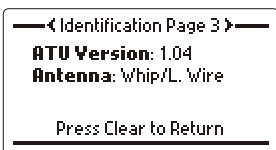

Show ATU firmware version and antenna selected

← Identification Page 3 →
Selcall IDs
INT1: 1234 OEM1: 9876
INT2: 123456 OEM2: 876543
 Press Clear to Return

This screen shows the default Selcall self ids for OEM and International type selcalls. INT1 is the default 4 digit ID for International or CCIR programmed channels. INT2 is the default 6 digit ID for International or CCIR programmed channels. OEM1 is the default 4 digit ID for OEM programmed channels. OEM2 is the default 6 digit ID for OEM programmed channels. If "N/A" is shown then that particular ID has not been set as yet. In the screen below neither OEM Selcall self id has been set.

← Identification Page 3 →
Selcall IDs
INT1: 1234 OEM1: N/A
INT2: 123456 OEM2: N/A
 Press Clear to Return

← Identification Page 5 →
Battery Rx: 14.2
Battery Tx: 14.0
PA Temperature: 20°
 Press Clear to Return

Shows receive and transmit battery levels, also shows PA temperature.

← Identification Page 6 →
Charge: 86%
 Estimated Charging Time
 1 hrs 57 mins
 Press Clear to Return

Shows estimated charge capacity of the battery and estimated time till discharge.

← Identification Page 7 →
GPS Coordinates
Lat: 32°05.727S
Long: 115°48.043E
 Press Clear to Return

If the GPS option is enabled and a GPS is fitted this screen will show the current GPS coordinates.

Display Options

Backlight Level

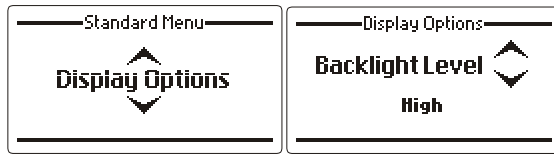

Allows the backlight level on the LCD display to be adjusted to one of three viewing levels:-High, Medium or Low.

Use the **Scroll keys** to select the level required (example Medium):-

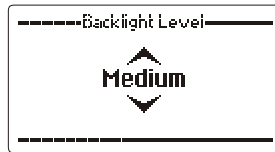

when the level required is displayed press the



key



Backlight Timeout

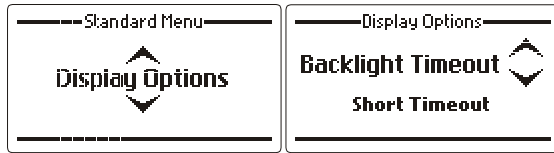

Allows the backlight timeout time to be set so the backlight stays on for a short time from the last key press, for a long time from the last key press or so that the backlight is permanently on or off.

Note:- Having the backlight off reduces the transceiver's power consumption.

Use the **Scroll keys** to select the required setting (example "Always on"):-



When the setting required is displayed press the  key

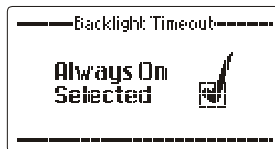

Call History

Whenever a Selcall, Telcall, All call, Group call, Sub group call, Pagecall, Statcall GPS or Emergency call is received or transmitted its details are held in a first in first out call history buffer.

Received calls that have not been viewed before are held in a section called "New Calls", received calls that have been viewed are held for future viewing in the "Inbox" all transmitted calls are stored in the "Outbox". Each history buffer can store up to 30 entries.

New Call

This section lists all types of Selcalls that have been received but not yet viewed:-

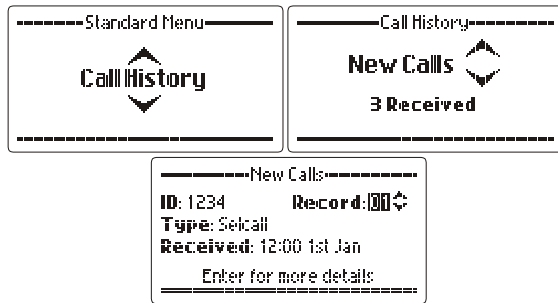

Inbox

This section lists all types of Selcalls that have been received and viewed and stored for future reference:-

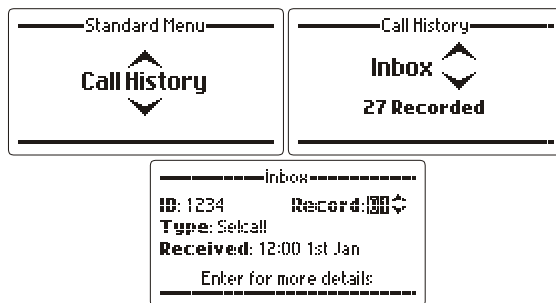

Outbox

This section lists all types of Selcalls that have been transmitted:-

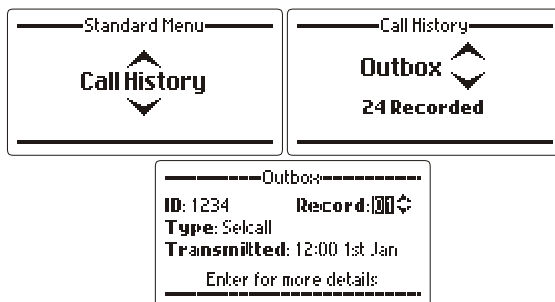

Navigation when in the “New calls”, “Inbox” and “Outbox” is always the same as shown in the “New Calls” example below:-

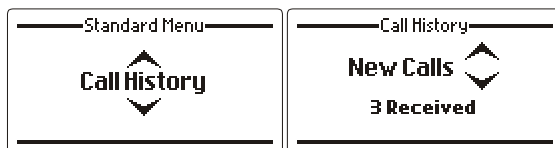

Either Use the **Scroll keys** to select the required record:-

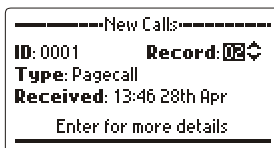
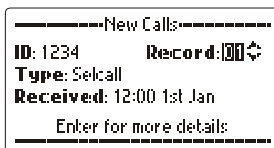

Or enter a record number using the numeric keys and press



```

-----New Calls-----
ID: 1234      Record: 21
Type: Selcall
Received: 12:00 1st Jan
      Enter for more details:
    
```

```

-----New Calls-----
ID: 0001      Record: 02
Type: Pagecall
Received: 13:46 28th Apr
      Enter for more details:
    
```



In all cases, when a record has been selected, press the  key for more details of the call:-

```

-----Inbox-----
Name: DUBAI BASE
Channel: 0002
Frequency: 2000.0 kHz
    
```

If the received Selcall ID is not listed in the transceiver Selcall ID book, associating it with a name, the following will be displayed:-

```

-----Inbox-----
Name: Unknown
Channel: 0002
Frequency: 2000.0 kHz
    
```

If the channel the incoming Selcall was received on has been deleted since the Selcall was received the following is displayed:-

```

-----Inbox-----
Name: DUBAI BASE
Channel: 0002
Frequency: Unknown
    
```

Address Books

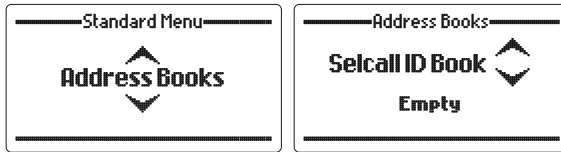

Selcall ID Book – Add a New Entry

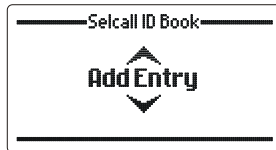

then press the  key

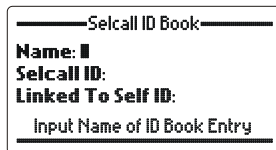

press  key if uppercase is required

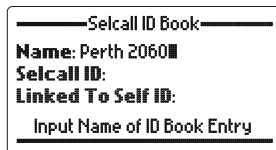

enter name to be associated with Selcall ID then press  key:-

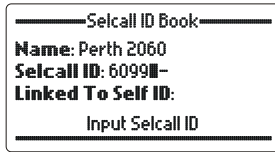

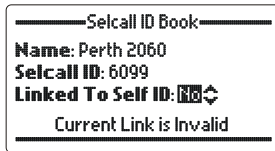

Enter Selcall ID number, four or six digits then press the  key:-

At this point Self IDs can be linked to the Selcall ID entered. This means that when a call is made to this Selcall ID the self ID associated with it will only be used. If no self IDs are available or the self id associated with the destination address is deleted the "Current Link is Invalid" message will be shown, otherwise the "Input Link Status" message is shown. If a self ID is linked to the Selcall ID then that Selcall ID can only be called on a channel that is programmed for the Selcall type of the linked self ID.

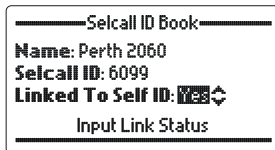
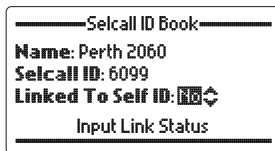

In the example below whenever a call to "Perth 2060" is made the transceiver self ID 9876 will be used and can only be sent on an OEM enabled channel. If a non OEM channel is selected then access to the "Perth 2060" address book entry is blocked.



Use the scroll keys to select the required "Linked to Self ID" setting then press the  key:-

— Selcall ID Book —

Selcall ID: 9878 ↕

Name: OEM 4 Digit

Type: OEM

Select a Self ID to Attach

If “Yes” is selected use the scroll keys to select the self ID to be associated with the Selcall ID then press  key add the new entry:-

— Selcall ID Book —

New

Entry

Selcall ID Book – Edit an Entry

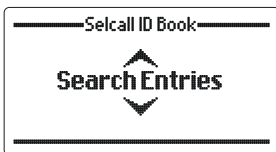

then press the  key.

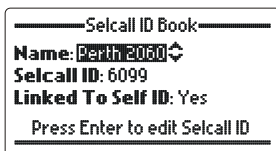

Scroll to the Selcall ID required.

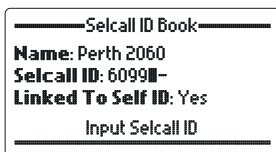

then press the  key.

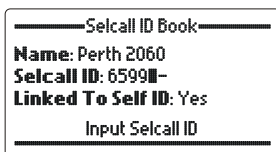

Enter in the new Selcall ID

then press the  key.

Selcall ID Book

Name: Perth 2060
Selcall ID: 6599
Linked To Self ID: Yes ↕

Input Link Status



then press the  key. Select the “Linked to Self ID” option.

Selcall ID Book

Selcall ID: 6599 ↕
Name: OEM 4 Digit
Type: OEM

Select a Self ID to Attach



then press the  key. If “Linked to Self ID” is set to “Yes” then the original self id is displayed.

Selcall ID Book

Selcall ID: 6599 ↕
Name: International ID 2
Type: International

Select a Self ID to Attach

Use the scroll keys to select the new self ID to link to if required,





then press the  key.

Selcall ID Book

Entry Updated 

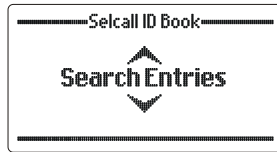
Selcall ID Book – Erase an Entry



then press the  key.

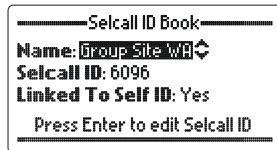

press the  key for more than two seconds. The erase entry verification screen will appear unless the address book entry is fixed. If this is the case then an error will be displayed on the screen.

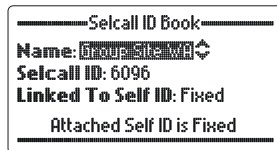

The address book entry is fixed. To delete this address book entry it must be modified in the 2000 Series Programming Software so that the fixed option is unchecked.

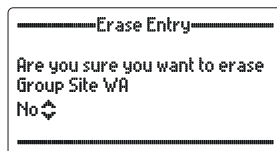

use the **Scroll keys** to select "Yes" to erase the address book entry.

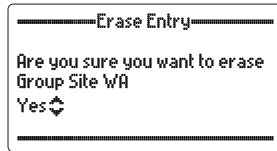

then press the  key.

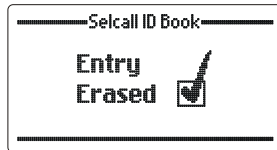

Phone Book - Add a New Entry

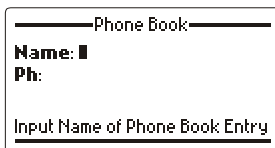

press the  key if uppercase required

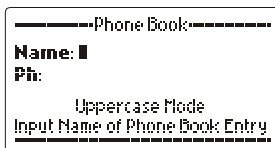

enter the name to be associated with telephone number

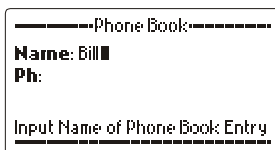

then press the  key

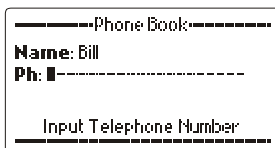

enter the telephone number using the numeric keys (up to 16 digits)

```
-----Phone Book-----  
Name: Bill  
Ph: 00618955555555-----  
Input Telephone Number
```



then press the key

```
-----Phone Book-----  
New Entry [F1]
```

Phone Book - Edit an Entry

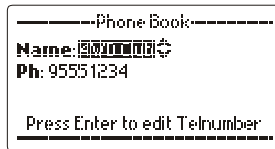
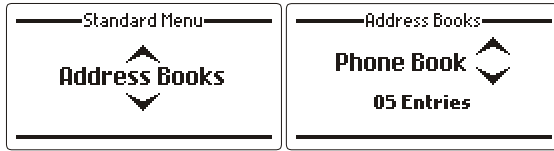



Either use the **Scroll keys** to scroll though the phone book to find the entry you want to edit

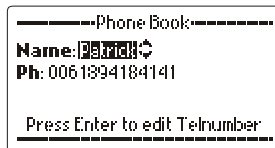

Or enter the first letter of the name you are looking for using the Alpha keys, for example, looking for the name Patrick:-

Key in 'p' using alpha keys, then use the **Scroll keys** to find the name:-



then press the  key

now to edit the telephone number press the  key

```

-----Phone Book-----
Name: Patrick
Ph: |-----
Input Telephone Number
    
```

enter the new telephone number using the numeric keys (up to 16 digits):-

```

-----Phone Book-----
Name: Patrick
Ph: 0061895559876|-----
Input Telephone Number
    
```



then press the key

```

-----Phone Book-----
Entry Updated ✓
    
```

```

-----Phone Book-----
Name: Patrick
Ph: 0061895559876
Press Enter to edit Telnumber
    
```

Phone Book - Erasing an Entry

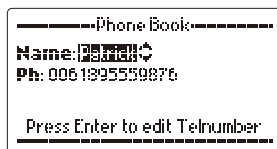

select the entry you want to erase using the **Scroll keys**.

press the key for more than two seconds

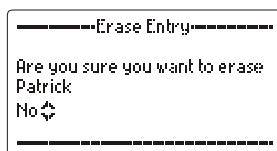

use the **Scroll keys** select "Yes"

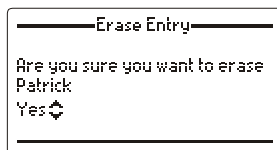

then press the



key

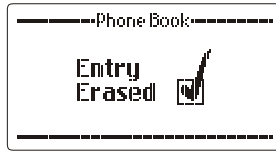

ALE Autofill Book

If the transceiver has the ALE option fitted then the ALE Auto fill address book menu will be available. See the ALE section of the manual for more information on the auto fill function.



If no auto fill calls have been received and the ALE auto fill is enabled then the display will show:

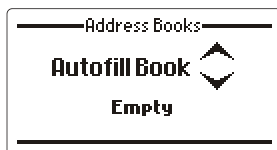

Or, if auto fill calls have been received and the ALE auto fill is enabled then the display will show:

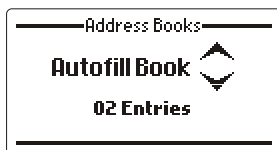

If the ALE auto fill option is disabled then the display will show:

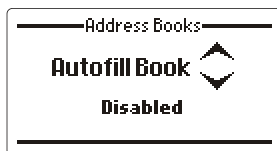

ALE Autofill Book – Reassign an Entry

Each time an auto fill call is received the calling station information is stored in a queue, on a first in first out basis once the auto fill queue is full. To permanently save an incoming auto fill call into the transceivers ALE network the alias needs to be reassigned.

Once auto fill calls have been received press the  key to search through the received calls.



then press the  key again, use the scroll keys to scroll through the received auto fill calls.

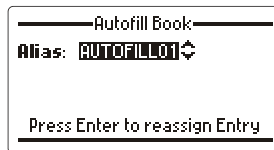

Once the desired auto fill id has been reached press the  key to reassign the alias of the received call.

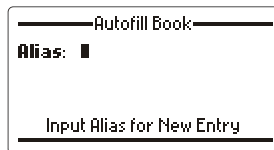

enter the new alias to be associated with the auto fill id.



then press  key to save the new alias:-

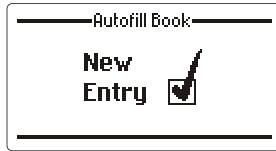



ALE Autofill Book – Erase an Entry

To erase an auto fill id go to the Auto fill book menu item,

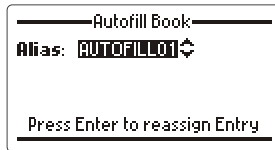

then press the  key, use the scroll keys to scroll through the received auto fill calls.



Once the correct ID has been selected press the  key for more than two seconds

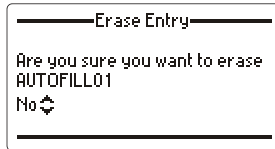

Use the scroll keys to select yes then press the  key

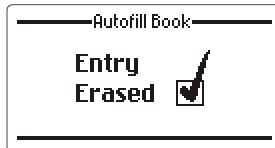
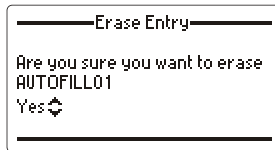

Audio Scrambler

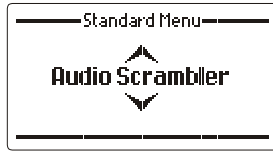

When using the internally fitted audio scrambler accessory PCB that provides backwards compatibility to the 900 series audio inversion scrambler (BCA20031) or the Transcript scrambler (BCA20054), the scramble code is set using this option. All stations using the scramblers require the same scrambler code to be entered:-

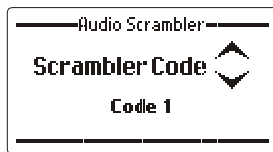

The code can be selected between 1 and 16 for the Transcript scrambler (BCA20054) or 1 and 32 for the audio inversion scrambler (BCA20031):-

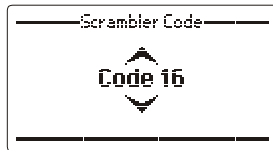

press the  key

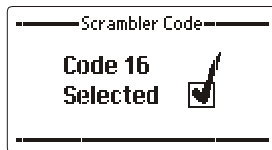

Note:- If using the internally fitted rolling code audio scrambler accessory PCB (BCA20054) the code is set on the unit before installation using an external programmer.

To Enable Scrambled Mode

Press the  key for more than two seconds, the “Scrambler Enabled” screen will be shown.

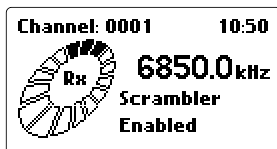

While the transceiver is in scrambled mode the “Scrambler On” message will be displayed.

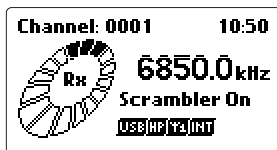

To Disable Scrambled Mode

Press the  key for more than two seconds, the “Scrambler Disabled” screen will be shown.



Antenna Select



This section allows the selection of the antenna type to be used with the 2090 manpack. When an un-tuned antenna such as the whip or a long-wire is to be used "Whip/Long-wire" is selected. This enables the automatic antenna tuner. If a 50 ohm broadband antenna or a tuned dipole is to be used select "50 ohm".

Use the **Scroll keys** to select the setting required (example "Whip/Long Wire" :-



press the  key



Protected Menu

Refer page 57 for details on how to access the protected menu.

General

Microphone Up/Down Keys



The keys on the top of the microphone can be assigned for two different functions, either as channel up/down keys or as volume control keys or they can be disabled:-

Use the **Scroll keys** to select the setting required (example "Mic keys disabled"):-

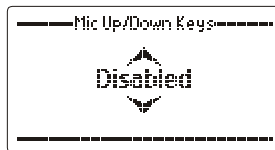

press the  key



Transmit "Over Beep"

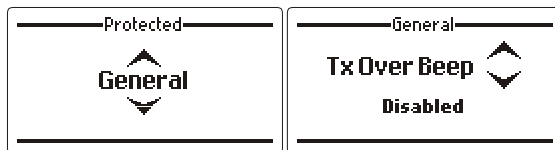

When selected the 2090 transceiver transmits a short tone when the PTT is released. It provides an audible indication to the operator at the remote station that the local station has stopped transmitting.

Use the **Scroll keys** to select the setting required (example "Tx Over Beep enabled"):-



press the  key

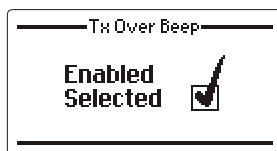

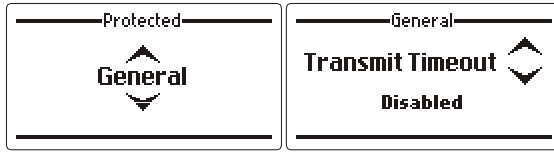

Transmit Timeout

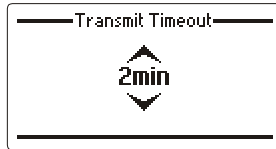

When this feature is enabled the 2090 transceiver will disable the transmitter if the PTT (push to talk button on the microphone) is held on for more than the time limit set below i.e. if the microphone is inadvertently jammed under a seat. Releasing the PTT will reset the transmitter. Settings available are "Disabled", 1 minute, 2 minutes, 3 minutes:-

Use the **Scroll keys** to select the setting required (example 2 minutes):-



When the setting required is selected press the  key

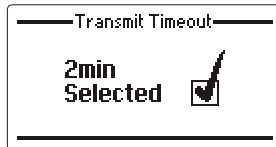

Channel Labels

This section enables the adding, editing or erasing of channel use labels, these labels are used during channel programming to indicate what particular channels are used for i.e. UNHCR Geneva:-

Edit Labels

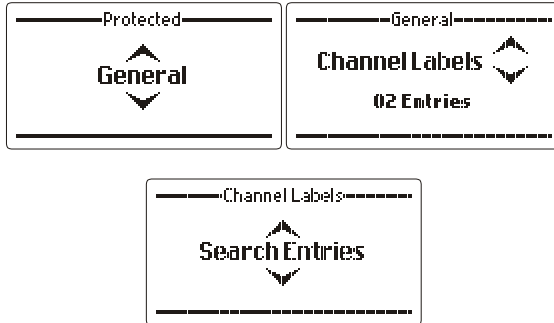

Either use the **scroll keys** to scroll through to the label you want to edit:-

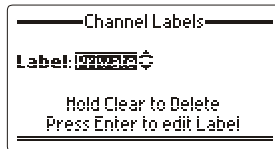

Or search for label you want to edit by entering the first letter of the label and using the **scroll keys** to select it:-

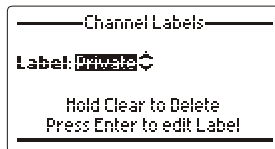

to edit the label press the key



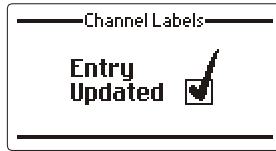

edit the entry when editing is complete press the  key

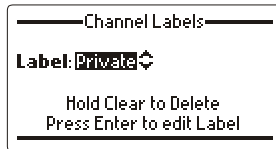

Delete a Label

Enter edit mode as shown above and select the label you want to delete:-



press the  key until the display below appears:-

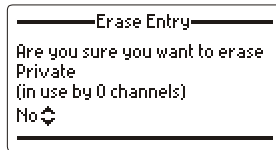

Use the **scroll keys** to select "Yes" you want to delete the entry:-

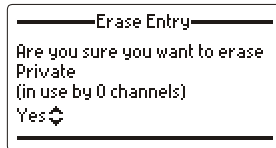

then press the  key.

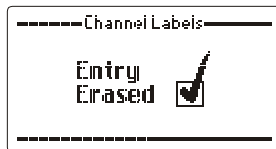

Add an Entry

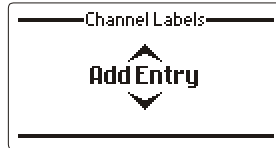

press the  key

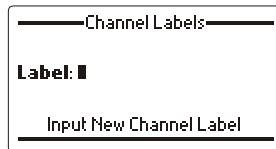

type in a new label using the Alpha keys:-

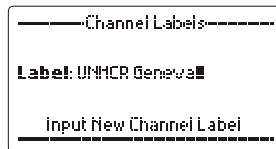

then press the  key.

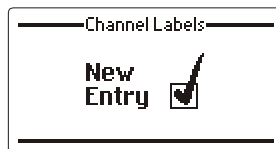

Setting the Clock

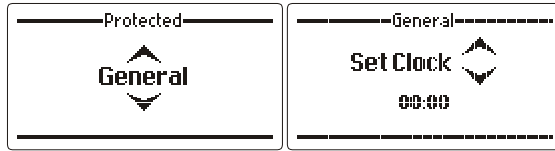

press the  key

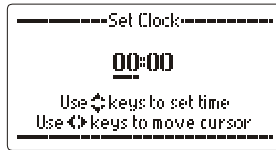

Use the Scroll keys and as shown on the screen to set the current time for example 13:15 (1:15 PM):-

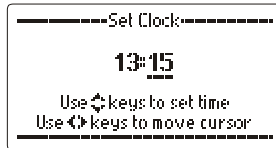

When time is set press the  key.

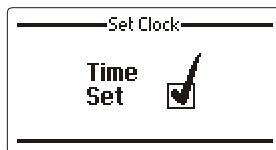

Setting the Date

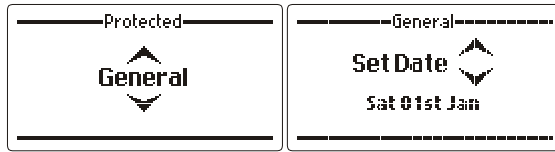

press the  key

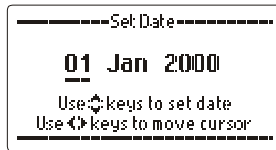

Use the Scroll keys and as shown on the screen to set the current date for example 04 June 2004:-

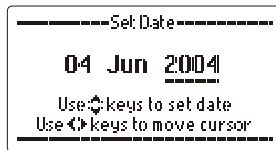

When date is entered press the  key

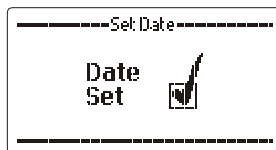

B.I.T.E. Test

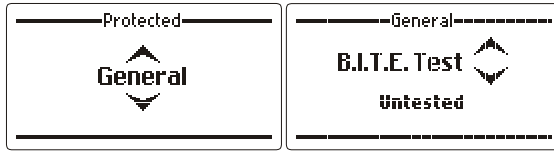

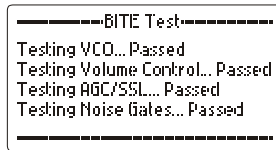

This section runs the transceiver's Built-in Test Equipment (B.I.T.E.) tests. The transceiver checks vital transceiver functions and reports the results as shown below:-

press the  key

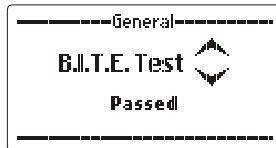

then press the  key to continue:-



press the  key to repeat the test or press the  key to finish.

Note:- The Audio and Signal strength mutes must not be selected when running the B.I.T.E. test or it may fail.

Option Installation



Options are installed in the Barrett 2090 transceiver by entering a PIN supplied by the manufacturer. This PIN is related to the electronic serial number of the transceiver. A different PIN is provided depending on the option or combination of options required to be fitted. Most options are fitted in the factory before dispatch.

press the  key



Enter the option PIN supplied by the manufacturer using the numeric keypad by the manufacturer then press the  key

For example if the PIN supplied is for all eight options, after entering the PIN the following is displayed:-



If an incorrect PIN is entered the following is displayed:-



Secure Call Code



When using the person to person voice scrambler both stations require the same scrambler code to be entered:-



Using the numeric key pad enter a four digit number:-

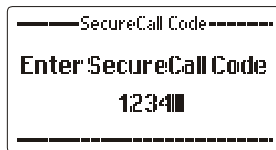

then press the  key



Security Level



This option allows the user to set the level of security used during secure voice communications. It changes the number of hops per second used by the encrypting algorithm. There are 2 choices:

- High** – 25 hops / second in Frequency Hopping mode
15 hops / second in Secure Call mode
- Standard** – 5 hops / second in Frequency Hopping mode
4 hops / second in Secure Call mode

Use the **Scroll keys** to select the required Security level:-



then press the  key



Upload Pack

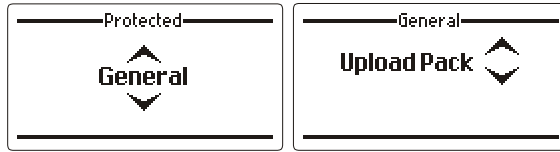

See section "Cloning (programming) from another transceiver"

Internal Modem



This menu option allows the user to enable or disable the internal HF data modem functionality of the transceiver.



press the  key



use the scroll keys to select the required setting then press the  key

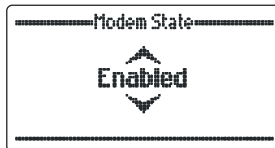

press the  key

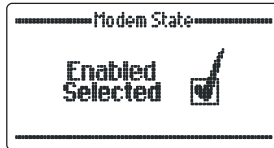

Note:- Once the “Internal Modem” option is enabled, transceivers cannot be controlled or programmed via RS232 communications. The “Internal Modem” must be disabled to allow re-programming or control of the transceiver through RS232 communications.

Scan Tables

Adding Channels to a Scan Table

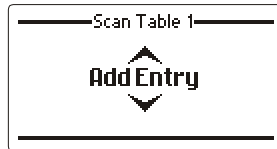
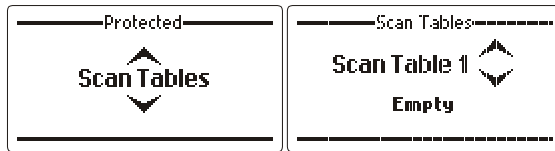

Use the **Scroll keys** to select the channel you wish to add:-

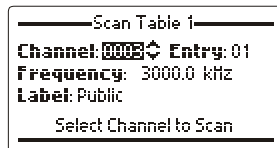

When the channel required is displayed press the



key

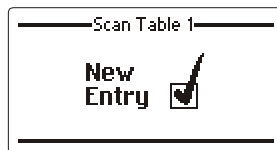

Editing Channels in a Scan Table

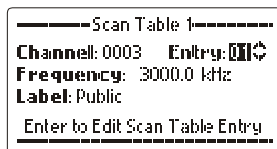

Either

Use the **Scroll keys** to select the channel you wish to edit:-

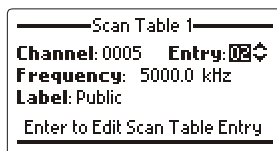

Or

Select the channel you wish to edit by entering the channel number (example channel 1):-

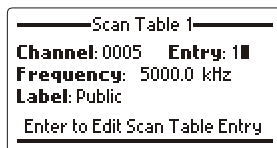

then press the  key

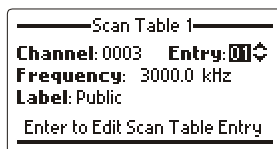



Then press the **ENTER** key to edit the channel number
 Use the **Scroll keys** to select the new channel for the scan table slot:-

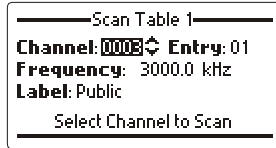

press the **ENTER** key to enter the new setting:-

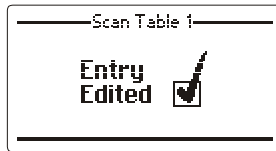

Erasing Entries in a Scan Table

Select the scan table and channel slot you want to remove using the steps above:-

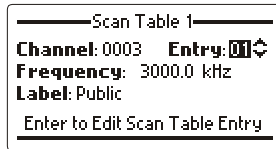

when the entry you wish to erase is selected press the **Clear** key until the following is displayed:-

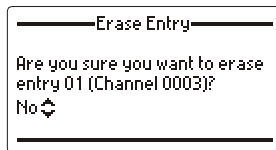

Use the **Scroll keys** to select "Yes" when you are sure you want to erase the entry:-

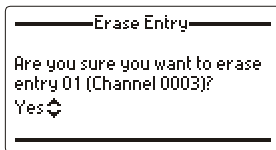

then press the



key

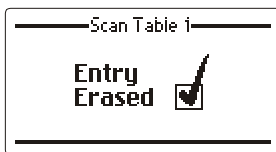

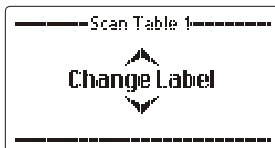
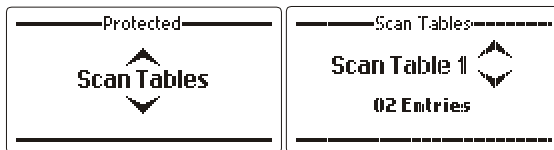

Note:- All channels are displayed in numerical order within the scan table with respect to the entry number, there are a maximum of 30 entries in each table.

Changing Scan Table Labels

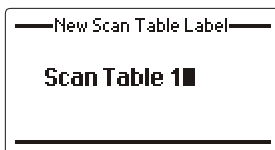

press the  key



Use the  key to clear the old label:-

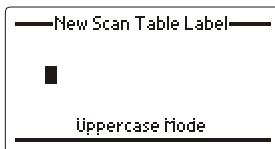

using the alpha/numeric keypad enter the new label:-

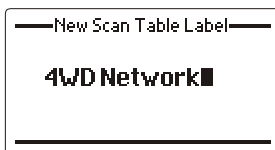

then press the



key

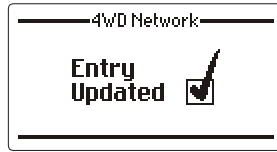

Scan Settings

Scan Rate

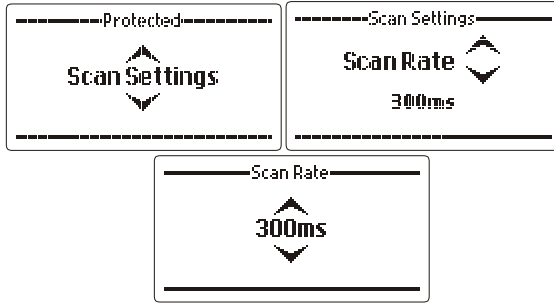

Selects the scan rate applicable to non-Selcall scan channels, selectable between 300 mS and 5 seconds per channel.

Use the **Scroll keys** to select the scan resume time required (example 700 mS):-

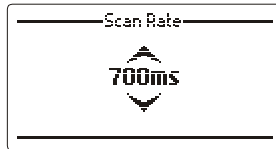

When the setting required is selected press the  key

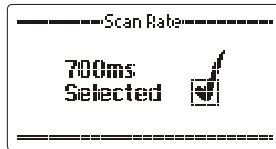

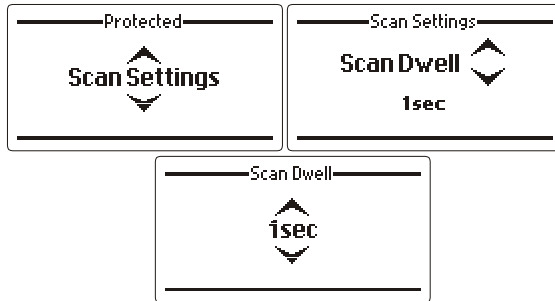

Scan Dwell

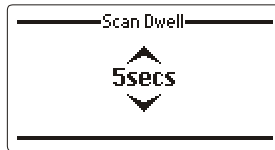

Selects the length of time the transceiver dwells(waits) on a channel after scan has been stopped by signal strength level (if signal strength level mute is set) or voice activity (if audio mute is set). The dwell time can be set from 1 to 10 seconds.

Use the **Scroll keys** to select the scan dwell time required (example 5 seconds):-



When the setting required is selected press the  key

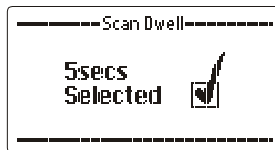

Scan Resume Time

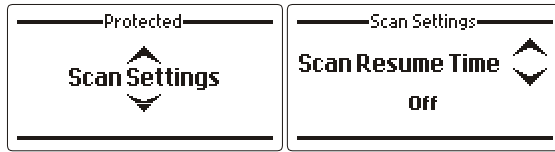

This section sets the time period after which the Barrett 2090 transceiver will automatically resume scanning from the last operation i.e. key press or PTT. The scan resume time period can be set between 1 and 30 minutes or it can be disabled.

Use the **Scroll keys** to select the scan resume time required (example 5 minutes):-



When the setting required is selected press the  key

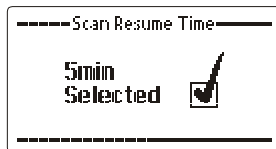

Scan Table Select



This section selects the Scan table to be used when the transceiver is put in scan, or if enabled, when scan resume occurs. There are 8 scan tables.

Note:- When scrolling through the scan tables, before selection, only those with channels entered will be displayed.

Note:- Channels can be added, removed and edited and scan tables named in the "Scan table" section.

Use the **Scroll keys** to select the scan table required (example scan table 1):-



When the scan table required is displayed press the  key

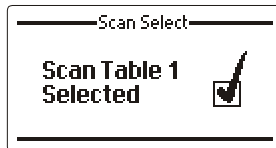

If none of the Scan tables have any channel entries the following is displayed:-

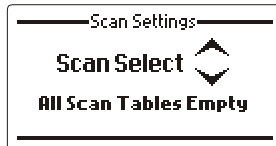

Note:- Direct entry into this section is available by pressing the  key for **more than two seconds**.

Mute Settings

Syllabic Mute Sensitivity

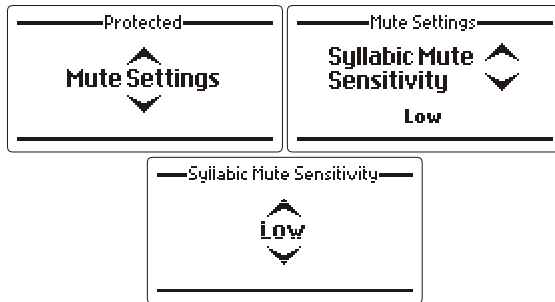

The sensitivity or “hardness of the syllabic mute (squelch) is set by this section. The mute can be set between low, medium and high sensitivity to voice activity on a channel.

Use the **Scroll keys** to select the setting required (example High):-



When the setting required is selected press the  key

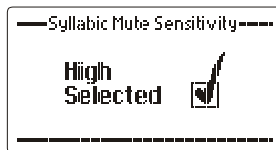

Signal Strength Mute Level

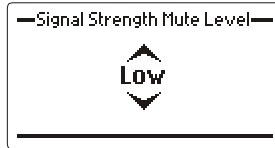

This section selects the level at which the Signal Strength Level (SSL) mute (squench) opens. Levels available are low, medium and high. When set to low the mute will open on a relatively low level of received signal, when set to high the mute will open on a relatively high level of received signal.

Use the **Scroll keys** to select the setting required (example High):-



When the setting required is selected press the **ENTER** key

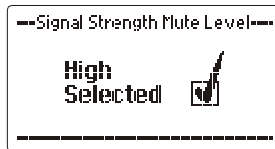

Selcall Settings

Self IDs



This allows the operator to set up all the self IDs for the transceiver. Up to 10 self IDs can be assigned. Any combination of 4 and 6 digit ID is permitted. Any combination of International or OEM Selcall type is also permitted.

Adding Self IDs

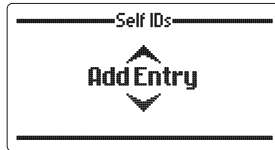

then press the  key.

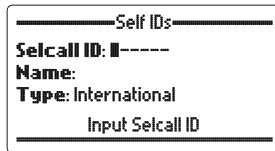

enter Selcall ID number, four or six digits.



then press the  key.

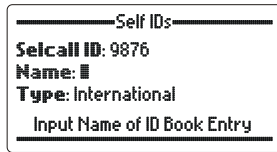

enter name to be associated with the Selcall ID, press  key if uppercase required.

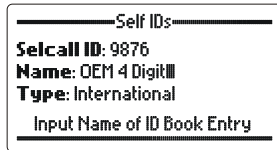

then press  key:-

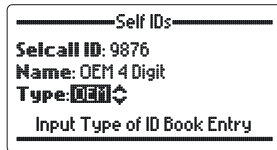

Use the scroll keys to select the Selcall ID format then press the  key:-

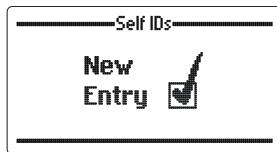

Modifying Self IDs



then press the  key.

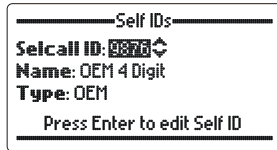

Scroll to the ID required.

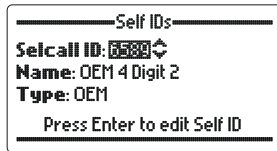

then press the  key.

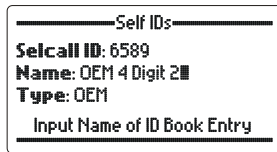

Change the ID name if required.

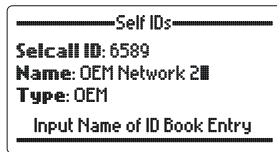

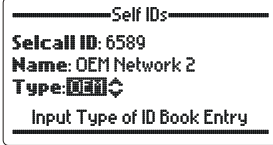

then press the  key.

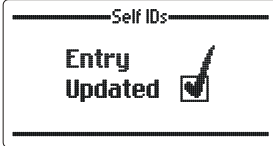

```
-----Self IDs-----
Selcall ID: 6589
Name: OEM Network 2
Type: OEM
Input Type of ID Book Entry
```

Change the Selcall format associated with the ID if required.



```
-----Self IDs-----
Entry Updated 
-----
```

then press the  key.

Deleting Self IDs



then press the  key.

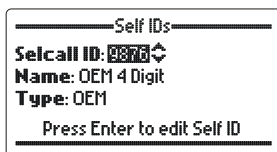

use the **Scroll keys** to select the entry you want to erase.

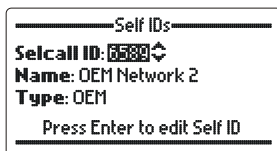

press the  key **for more than two seconds**. The erase entry verification screen will appear unless the ID is set as a default ID or is attached to a fixed address book entry. If this is the case then an error will be displayed on the screen.

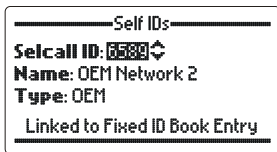

The self ID is attached to an address book entry which is fixed. To delete this self ID the address book entry must be modified in the 2000 Series Programming Software to have the self ID detached from it.

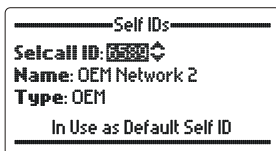

The self ID is set as one of the 4 default self IDs. To delete this self ID it must be removed from the default ID list.

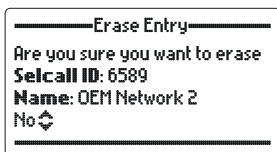

use the **Scroll keys** to select "Yes" to erase the ID.

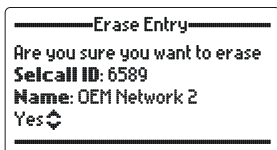

then press the  key.

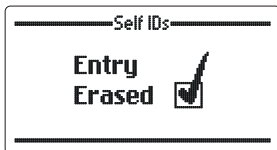

Selcall INT 1 – Setting Default International 4 Digit Selcall Self ID

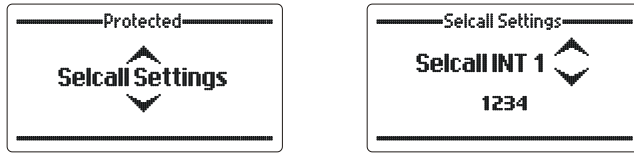

Selcall INT1 - Used as the default 4 digit International or CCIR (WA2 in Australia) self ID when sending calls.

Selcall INT 2 – Setting Default International 6 Digit Selcall Self ID

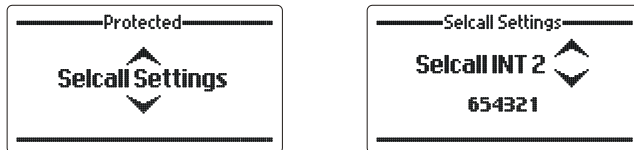

Selcall INT1 - Used as the default 6 digit International self ID when sending selective calls.

Selcall OEM 1 – Setting Default OEM 4 Digit Selcall Self ID

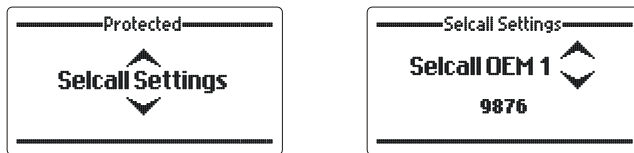

Selcall OEM1 - Used as the default 4 digit OEM self ID when sending calls.

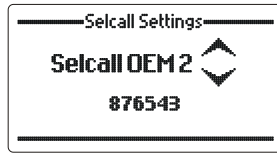
Selcall OEM 2 – Setting Default OEM 6 Digit Selcall Self ID

Selcall OEM2 - Used as the default 6 digit OEM self ID when sending selective calls.

Note:- We recommend that the self ID should not be set to X000, XX00 or XXX0 as these are reserved Selcall numbers for Allcall, group-call or sub-group-call use.

Selcall Alarm



The Selcall received audio annunciation can be turned on or off using this function; this is useful when the transceiver is used in covert operations. Reception of the Selcall continues to be displayed visually on the display.

Use the **Scroll keys** to select the setting required (example shows selection of alarm "On");-

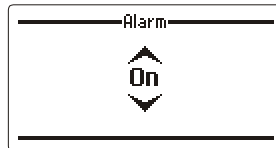

press the  key





Selcall Transmit Tones Audio Level

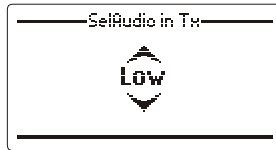

To confirm transmission of a Selcall the Selcall tones are normally output on the transceiver loudspeaker. In certain situations this is not required or the tone volume requires adjusted. This section allows the Selcall audio to be disabled or set to two volume settings, Low or High.

Use the **Scroll keys** to select the setting required (example Selcall volume "Low" :-



When the setting required is selected press the  key

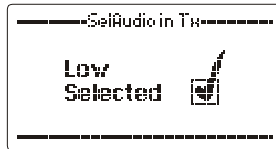

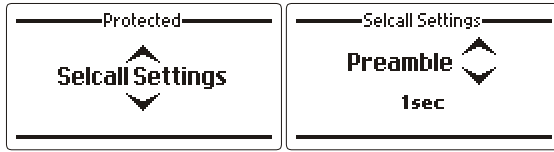

Selcall Pre-amble Length Setting

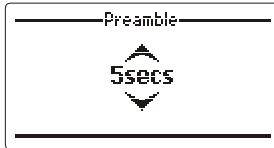

The Selcall pre-amble length can be set between 1 and 10 seconds depending on how many channels are used in the scan table being used. Allow 500 mS for each Selcall channel to be scanned plus one second, E.g. to scan 8 Selcall channels:-
 $500 \text{ mS} \times 8 + 1 \text{ sec.} = 5 \text{ seconds.}$

Use the **Scroll keys** to select the Selcall pre-amble length required (example "5 seconds"):-



When the setting required is selected press the  key



TXCVR Lock



This section enables the network operator to send a special key (programmed into a transceiver during programming) by Selcall to disable that transceiver. The transceiver remains locked until an unlock code is entered.

This function can be used if the transceiver has been stolen and it is being used illegally.

The lock call will be made on the channel selected before entering this function. The channel number is shown on the TXCVR display.

Before proceeding if the channel presently selected is not a Selcall channel the following is displayed

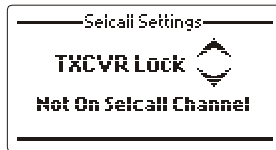

Select a channel that you expect the transceiver you want to lock is on and that has Selcall programmed

press the  key

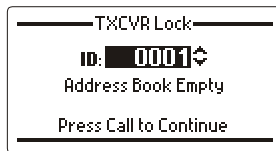

enter the Selcall number of the transceiver you wish to disable (see entering Selcall numbers in the Selcall section)

press the  key

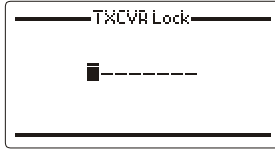

enter the 8 digit numeric lock code (this was loaded into the transceiver when initially programmed for the network)

press the  key

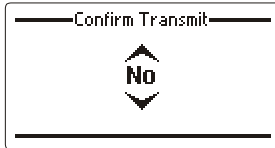

If you are **absolutely sure** you want to lock the transceiver with Selcall ID entered use the Scroll keys to select "Yes"

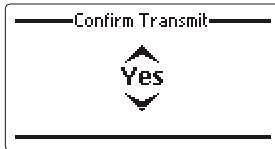

press the  key

The transceiver will now send the lock call. A revertive call from the transceiver being locked will confirm the action.

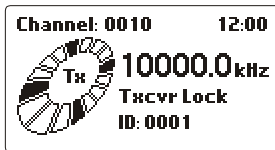

A transceiver that has been locked by this process can only be unlocked by using the Barrett programming software. See the programming software for details.

OEM Privacy key



When using OEM Selcall protocol, OEM calls can either be sent plain text or encrypted. This is done by using either the privacy key programmed by the programming software or if no privacy key is programmed the default value of 9999999. Selecting "On" will encrypt calls, selecting "Off" will send plain text calls.

Use the **Scroll keys** to select the setting required (example shows selection OEM Privacy key "On"):-

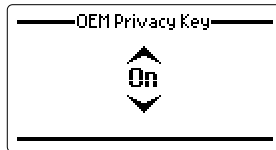

press the  key



Audio Settings

Audio Bandwidth



This section allows the audio bandwidth to be tailored to an operator's comfort requirements. Settings available are full bandwidth - 300 Hz – 1.5 kHz, 300 Hz – 2.0 kHz, 300 Hz – 2.5 kHz , 300 Hz – 3.0 kHz.

Use the **Scroll keys** to select the audio bandwidth required (example "300Hz to 2.5 kHz"):-



When the audio bandwidth required is displayed press the  key

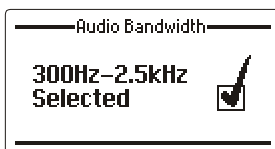

“Beep” Volume Level

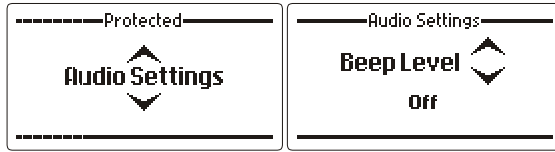

This section is used to set or disable the annunciation beep volume levels. These are the various tones associated with key presses. In covert operations these can be disabled, in other operations these are set for operator comfort. Settings are “Off”, “Low” or “High” (example shown “beep” tones High):-

Use the **Scroll keys** to select the “beep” volume level required (example shown “beep” tones level “High”):-



When the “beep” level required is displayed press the  key



Receiver Audio Path Configuration



The section sets where the unprocessed receiver audio in the transceiver is sourced. Normally this is set to internal; in this case the transceiver's receiver provides the unprocessed audio.

When used with a remote receiver, in split site operations, it can be set to external, in this case unprocessed receive audio from the remote site can be input into the auxiliary sockets 600 ohm balanced audio port.

Use the **Scroll keys** to select setting required (example shows "External audio"):-



press the  key

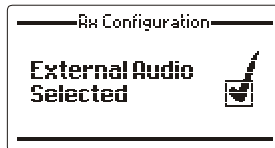

Transmitter Audio Path Configuration

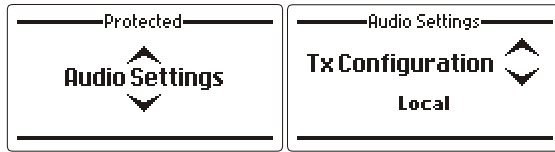

The section sets where the transmitter audio in the transceiver is sourced. Normally this is set to internal; in this case the transceiver's microphone provides the transmitter audio.

When used with a remote site operation, it can be set to "remote", in this case the transmit audio is input into the auxiliary sockets 600 ohm balanced audio port.

Use the **Scroll keys** to select setting required (example shows "Remote"):-

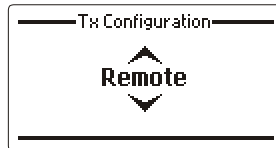

press the  key

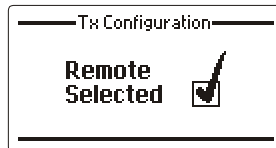

Line Audio

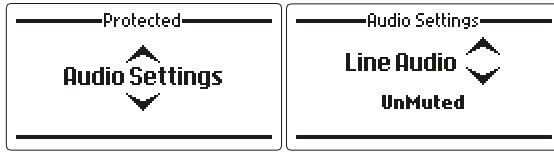

This section sets the muting condition of the 600 ohms balanced audio line output on the rear auxiliary connector. The line output can be set to “Un-Muted” or “Follows Mute”. When set to “Follows Mute” the line output is muted in the same manner as the speaker output and follows the mute condition currently in use. The line output is usually set to “Un-Muted” when using data modems.

Use the **Scroll keys** to select the noise reduction “depth” required (example “Follows Mute”):-



press the  key



Noise Reduction

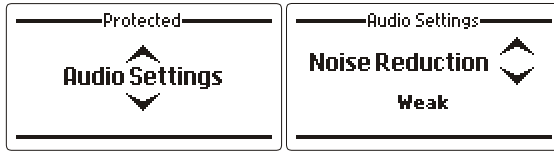

This section allows the DSP noise reduction “depth” to be adjusted to suit the operator’s comfort requirements. Settings available are Weak, Medium and Strong. It should be noted that as the “depth” is increased the processed human voice gets a more metallic quality.

press the  key

Use the **Scroll keys** to select the noise reduction “depth” required (example “Medium”):-

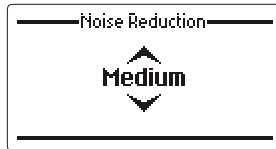

When the noise reduction required is displayed press the

 key

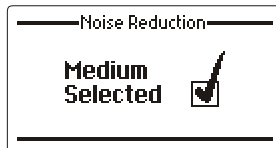

RF Settings

Optional IF Filter Enable

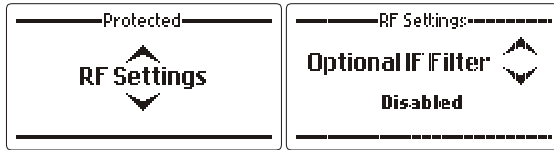

When enabled the optional IF filter (if physically fitted) is selected automatically when AFSK or CW mode is selected. This is useful when the transceiver is used in some data transmission applications.

Use the **Scroll keys** to select the setting required (example shown "Enabled"):-

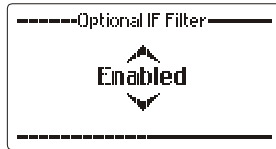

press the  key

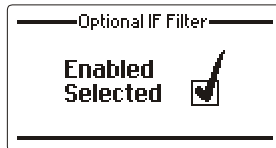

Note:- This setting is only available if the narrow filter setting is selected during programming from the programming software.

Receiver Pre-amplifier

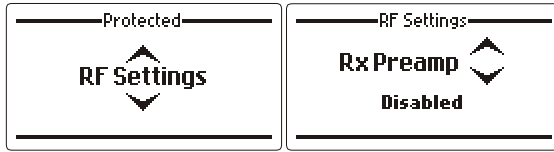

Enables or disables RF preamplifier, this preamplifier provides and additional receiver gain of 5dB. Generally the RF pre-amplifier is switched off when an automatic mobile antenna is in use as these antenna have an inbuilt RF pre-amp.

Use the **Scroll keys** to select the setting required (example shown "Enabled"):-

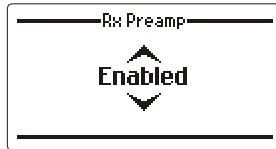

press the  key

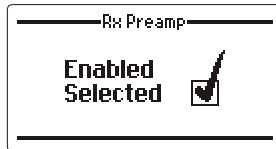

Clarifier Range

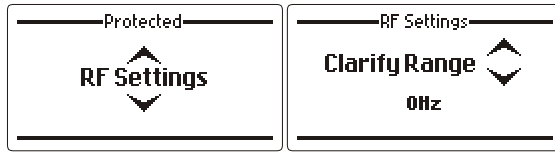

This menu item allows the user to set the clarifier range or disable the clarifier; the range can be set to +/-50 Hz, +/-150 Hz or +/-1 kHz.

Use the **Scroll keys** to select the clarifier range required (example shown +/-1 kHz):-



When the clarifier limit required is displayed press the



key



Noise Blanker Threshold

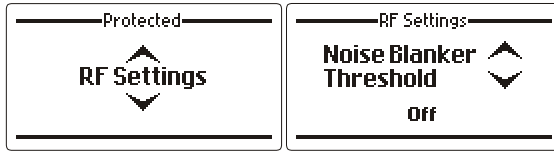

This menu item allows the predictive noise blanker to be switched on or off and allows the selection of three threshold levels. The noise blanker is useful to reduce the interference caused within vehicles with petrol engines.

Note:- The noise blanker will not be effective in situations where external power line noise etc is blanketing the receiver.

Use the **Scroll keys** to select the setting required (example shown "Threshold Low"):-

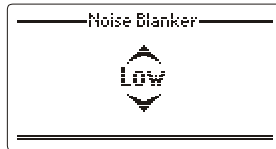

press the  key

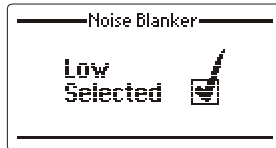

Note:- In certain situations noise blankers can cause Intermodulation in receivers, in these cases the noise blanker should be disabled.

AGC Hang

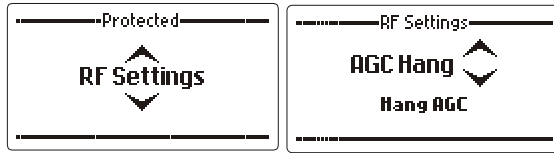

This section allows the AGC configuration of the receiver to be set to either “Hang AGC” or “Hang Off”. The selection depends on the receiver environment and should be set for optimum receiver performance. In the presence of high static and sporadic noise, the function of the hang AGC may result in gaps in the received signal due to the slow AGC recovery.

Use the **Scroll keys** to select the AGC Hang (example shown Hang Off):-



When the AGC Hang required is displayed press the



key



I/O Settings

RS-232 Out

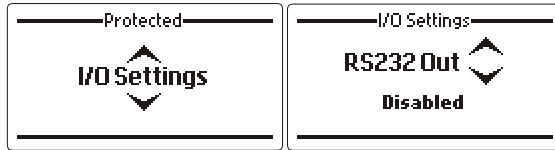

This section enables or disables RS-232 Selcall information output from the transceiver via the 25 pin auxiliary connector.

Use the **Scroll keys** to select the setting required (example shown "Enabled"):-

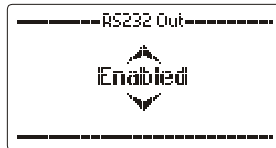

When the setting required is displayed press the  key

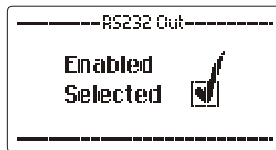

Note:- This command does not allow RS-232 control of the transceiver as enabled when the RS-232 option is fitted. It is used to control the output of Selcall information used by some external programs such as vehicle tracking.

External Alarm

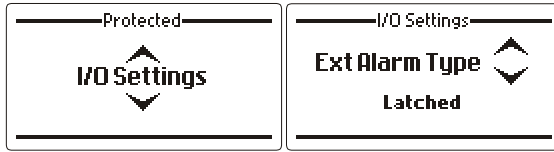

This section sets the action of the external alarm output, on pin 17 of the 25 pin D auxiliary connector, activated when a Selcall is received by the transceiver. It can be set to either a pulse output (for use with a horn) where the output is activated 15 seconds on, 15 seconds off; or a constant output (for use with a rotating beacon). Both are reset by pressing the clear key or action of the PTT button.

Use the **Scroll keys** to select the setting required (example shown "Pulsed"):-

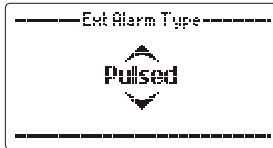

press the  key

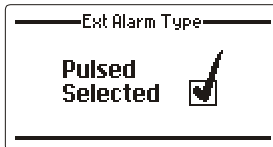

Antenna type



This section sets antenna type or if a linear amplifier is to be used with the 2090 manpack fitted into the 2090 Vehicle docking.

Selections available:-

“Base Station”

Select when base station antennas such as the Barrett 2012 series are used. No tuning signals are emitted on channel change. This selection should also be used when operating with a Barrett 2014 manual tapped whip.

“910 Mobile antenna”

Select when using a Barrett 910 automatic tuning mobile antenna.

“911 Automatic Tuner”

Select when using a Barrett 911 automatic tuner.

“Linear amplifier”

Select when using the 2090 with a Barrett 975 series linear amplifier.

“2019 Mobile antenna”

Select when using a Barrett 2019 automatic tuning mobile HF antenna.

“Loop Antenna”

Select when using the 2018 Mobile magnetic loop HF antenna

“Linear with ATU”

Select when using the 2050 with a Barrett 2075 series linear amplifier fitted with an automatic tuning unit.

Use the **Scroll keys** to select the type of antenna or a linear amplifier (example shown "2019 Mobile antenna):-

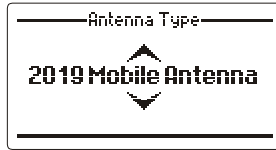

When the setting required is displayed press the  key

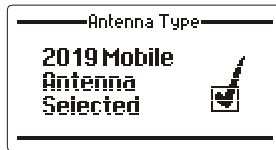

GPS Receiver Enable

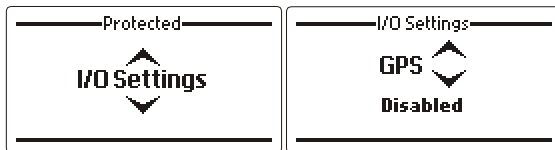

This section enables or disables the external GPS receiver input (example “disabled”):-

Use the **Scroll keys** to select the setting required (example shown –“Enabled”):-

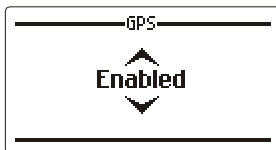

press the  key

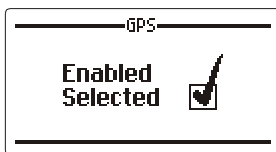

Note:- An external GPS receiver is required for GPS functions. If this option is enabled and a GPS is not connected to the 2090 a **warning message will appear on the display “GPS Unavailable”**

Line Output Level Adjust

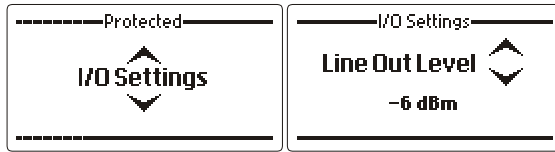

This section adjusts the output level of the auxiliary 600 ohm balanced audio output port. The level can be set to -6dBm, -3dBm, -0dBm, +3dBm, +6dbm and +9dBm.

Use the **Scroll keys** to select the level required (example shown - 3dBm):-

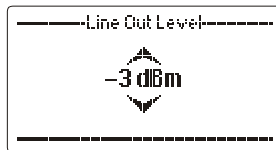

When the level required is displayed press the



key

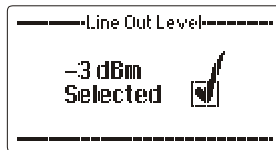

Line Input Level Adjust

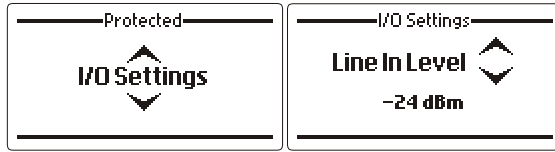

This section adjusts the input level sensitivity of the auxiliary 600 ohm balanced audio input. Sensitivity can be adjusted to -24dBm, -18dBm, -12dBm, -6dBm and 0dBm.

Use the **Scroll keys** to select the level required (example shown -12dBm):-



When the level required is displayed press the



key

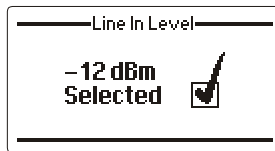

Automatic Link Establishment (ALE) (Option)

ALE System Overview

The Barrett Automatic Link Establishment (ALE) controller option simplifies the operation of HF networks, the ALE option automating many of the procedures necessary to establish and maintain an HF link.

The Barrett 2090 ALE controller option provides complete inter-operability as required by FED-STD-1045 and U.S. MIL-STD-188-141B standards.

HF network stations equipped with ALE controllers automatically scan a pre-selected set of channels, listening for ALE calls. If sounding is selected stations at periodic intervals send out "sounding calls" to other stations. These signals are analysed for link quality and stored in the "sounded" stations. All stations gradually build up a table of parameters which determines best channels to use to link between specific stations. These tables are used by the ALE controller to determine the best channel to connect on when commanded by its operator to communicate with another station.

The Barrett 2090 ALE controller's powerful memory stores up to 10,000 sets of LQA information, 100 channel configurations, 20 self-address configurations and 100 other address configurations.

Operation Overview

The ALE network parameters are determined by a network supervisor, this person programs all the transceivers in the network with the required addressing and channel information using the ALE fill program. This is a PC based program used to transfer pre-determined network information into each transceiver. A separate manual is provided as a guide to ALE network setup and for the operation of ALE fill program. As ALE's prime purpose is to automate many of the procedures necessary to establish and maintain an HF link, it is only necessary for the operator to enter the station he wishes to call and activate ALE call sequence as described in the following section.

Within the protected menu ALE section various operational parameters can be changed as required by the operator. The section titled "ALE menus" describes these functions.

To Commence Scanning

Note:- You should have selected the required scan list before you commence scanning, refer to the section “ALE scan list select” in the ALE protected menu.

Press the  key

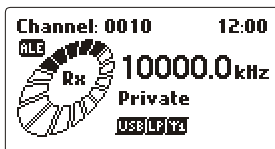

the 2090 transceiver will now be ALE scanning and ready to accept ALE calls, receive “Soundings” and transmit “Soundings” (If “Sounding” is enabled on your transceiver)

During ALE scanning the following messages may be displayed:-



This occurs when your station receives an ALE sounding from another station in the network.

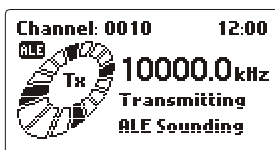

This is displayed when your station transmits a “sounding”

Note:- Your station would have to have “Sounding” enabled.

Linking to Another Station in an ALE Network

press the  key

select "ALE Call" with the scroll keys



then press the  key



select the station ID of the station you wish to call (the "To" ID)
(see the section below "Selecting ALE Station IDs")



then press the  key



select the station ID you are calling from (your self ID can be varied, (the "From" ID)) (see the section below "Selecting ALE station IDs")



then press the  key

the ALE call sequence will now commence:-



linking in progress:-



the link is established, an audible alarm will sound after which you can start communication with the station you called:-



Or if you already had two links established:-



The following error messages may be displayed:-

For various reasons the link attempt failed i.e. no response from the called station or the link was rejected by the called station:-



You attempted to make a call but for various reasons the system cannot make the call i.e. incorrect self address, no presets available, no valid LQA's available:-



Making a Netcall

A maximum of 20 networks, programmed with the ALE fill software can be called using the Netcall facility. Each network can consist of up to 15 ALE stations.

press the  key

select "ALE Call" with the scroll keys



then press the  key

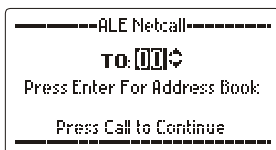

select the network you wish to call (the "To" ID)
(see the section below **"Selecting ALE Station IDs"**)

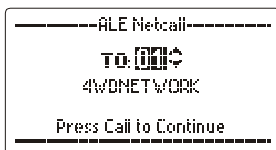

then press the  key



select the station ID you are calling from (your self ID can be varied, (the "From" ID)) (see the section below **"Selecting ALE station IDs"**)



then press the  key

the ALE call sequence will now commence:-



linking in progress:-



the link is established, an audible alarm will sound after which you can start communication with the station you called:-



Or if you already had two links established:-



The following error messages may be displayed:-

For various reasons the link attempt failed i.e. no response from the called station or the link was rejected by the called station:-



You attempted to make a call but for various reasons the system cannot make the call i.e. incorrect self address, no presets available, no valid LQA's available:-



Sending an ALE Text Message to Another Station in an ALE Network

press the  key

select "ALE Message" with the scroll keys:-



then press the  key



select the station ID of the station you wish to call (the "To" ID)
(see the section below "**Selecting ALE Station IDs**")



then press the  key



select the station ID you are calling from (your self ID can be varied, (the "From" ID)) (see the section below "**Selecting ALE station IDs**")



then press the  key

use the **Scroll** keys to select **either**:-



Or



If you selected "**New Message**":-



then press the  key



Enter the message using the alpha/numeric key pad



If you selected "Preset Message":-



press the  key



Use the **Scroll keys** to view the rest of the message:-



Or use the  or  keys to select other preset messages:-

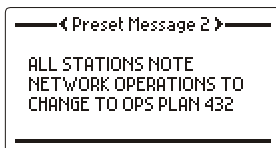

When the **“Preset Message”** is selected or the **“New Message”** is

entered, press the  **CALL** key

the ALE call sequence will now commence:-



linking in progress:-



the link is established, an audible alarm will sound after which you can start communication with the station you called:-



or if you already had two links established:-

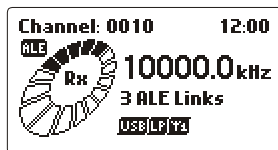

The following error messages may be displayed:-

For various reasons the link attempt failed i.e. no response from the called station or the link was rejected by the called station:-

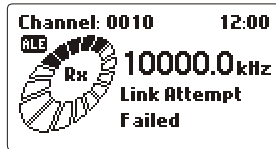

You attempted to make a call but for various reasons the system cannot make the call i.e. incorrect self address, no presets available, no valid LQA's available:-



Telephone Call to ALE Stations with Telephone Interconnect Facilities

press the  key

select "ALE Phone" with the scroll keys



then press the  key



select the station ID of the station you wish to call (the "To" ID)
(see the section below **"Selecting ALE Station IDs"**)



then press the  key



select the station ID you are calling from (your self ID can be varied, (the "From" ID)) (see the section below **"Selecting ALE station IDs"**)



then press the  key

Either enter the telephone number using the numeric keypad (a number up to 16 digits)



Or if you think that telephone number is in the phone book use the **Scroll keys** to find the name and number you want to call:-



Or if you know the name associated with the telephone number in

the phone book press the  key and either enter the first letter of the name you want to call using the alpha keypad and use the **Scroll keys** or use the **Scroll keys** to find the name you want to call:-



Or press the  key and the phone number previously called will be called again.

the ALE call sequence will now commence:-



linking in progress:-



the link is established, an audible alarm will sound after which you can start communication with the station you called:-

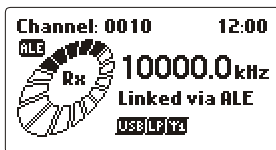

Or if you already had two links established:-



The following error messages may be displayed:-

For various reasons the link attempt failed i.e. no response from the called station or the link was rejected by the called station:-



You attempted to make a call but for various reasons the system cannot make the call i.e. incorrect self address, no presets available, no valid LQA's available:-



Selecting ALE Station IDs

Unlike Selcall IDs which you can enter yourself into the transceivers Address books, ALE network station IDs are pre-programmed into your transceiver. This is usually performed by your network administrator prior to deployment using the Barrett ALE fill program via the RS-232 port on the Auxiliary socket from a PC or Laptop

Note:- the same method is used to select the "To" and "From" ID, the "To" ID is shown below:-

Either enter the station ID using the numeric keys (the number of the station you wish to call, see "Station ID ranges")

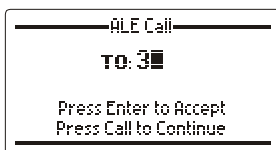

Or all the stations are in the address book, use the **scroll keys** to find the station you want to call, then

press the  key

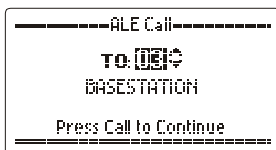

Or if you know the name of the station press the  key and either enter the first letter of the name you want to call using the alpha keypad then use the **Scroll keys** or use the **Scroll keys** to find the name of the station you want to call (example "b" entered):-



Receiving an ALE Call

Various types of ALE call can be received as described below. When an ALE call to your station commences the following is displayed on your transceiver:-

A station in the ALE net is attempting to establish a link to your station:-



Your station is now linked, an audible alarm sounds:-



This is a normal call and conversation can now commence.

Or



An address has matched an incoming **Wildcard** address. **Wildcard** addresses have special characters (question marks) in them that do not require an exact match with the local address to link E.g. "FIELD?" will link with any station that has a self address starting with FIELD and ending in a single additional character (for example, FIELD1 or FIELDA). A station that linked using a Wildcard call may not be the only station in the link.

Stations respond to a **Wildcard** call in random slots.

Or



An address has matched an incoming **Anycall**. An **Anycall** is a special call type that may link with any station(s) listening.

Stations respond to **Anycalls** in random slots.

Or





An address has matched an incoming **Allcall**. An **Allcall** is a special call type that may link with any station listening.

Stations do not respond to **Allcalls**. Since the station which initiated the call does not receive any link acknowledgements it cannot determine which station(s) have accepted the link.

With all the above calls an alarm will sound for 60secs. After pressing a key, the following pages appear. If the 60sec alarm times out the system blips periodically (~5sec intervals).

Shows the address called i.e. one of your addresses:-



Pressing the  or  scrolls between the two pages of call data. The following page shows the address of the station that called you:-



Pressing the key displays the link status:-



Or if more than one link is in progress (example 3 links):-



Receiving an ALE Message

When an ALE link to your station commences the following is displayed on your transceiver:-

A station in the ALE net is attempting to establish a link to your station:-



Your station is now linked and has received an ALE message, an audible alarm sounds:-



If after 60 seconds no key has been pressed the alarm will stop and regular 'blips' will be heard, indicating a call was received in your absence. Pressing any key will display the message received:-





Pressing the  key shows the address that the station called i.e. one of your addresses:-



Pressing the  again shows the address of the station that called you:-

← ALE Message Page 1 →
From
FIELDBASE

Pressing  returns you to the previous screen etc.

Pressing the  key or using PTT will return you to the main screen.

Receiving an ALE Telephone Call

If the RS-232 output is disabled (see I/O section of the Protected Menu) ALE telephone call requests are displayed on the transceiver front panel as follows:-

When an ALE link to your station commences the following is displayed on your transceiver:-

A station in the ALE net is attempting to establish a link to your station:-



Your station is now linked and has received an ALE phone number, an audible alarm sounds:-



If after 60 seconds no key has been pressed the alarm will stop and regular 'blips' will be heard indicating a call was received in your absence. Pressing any key will display the received message:-

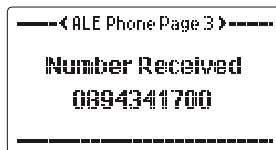



Pressing the  key shows the address that the station called i.e. one of your addresses:-



Pressing the  again shows the address of the station that called you:-

```
-----<ALE Phone Page 1>-----  
From  
RELEASE
```

Pressing the  returns you to the previous screen etc.

Pressing the  key or using PTT will return you to the main screen.

Note:- Normally when using this ALE telephone number function the receiving transceiver is connected to a automatic telephone interconnect unit such as the Barrett 960 or Barrett 2060, in this case the RS-232 output is enabled the receipt of an ALE telephone call request is not displayed as above and the telephone interconnect takes control of the transceiver.

Receiving an ALE Netcall

When an ALE link to your station commences the following is displayed on your transceiver:-

A station in the ALE net is attempting to establish a link to your station:-



Your station is now linked, an audible alarm sounds:-





Your address has matched an incoming Netcall, a call to a number of stations in one call. Each station must respond to confirm the Netcall is established with the calling station. Each station responds in pre-determined slots.

If after 60 seconds if no key has been pressed the alarm will stop and regular 'blips' will be heard indicating a call was received in your absence. Pressing any key will display the call data:-

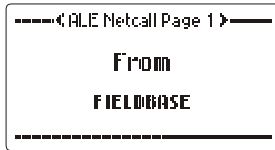

Pressing the  again shows the address of the station that called you:-



Pressing  returns you to the previous screen etc.

Pressing the  key or using PTT will return you to the main screen.

Closing Individual ALE links

You must be linked to close an ALE link:-



Or if more than one ALE link is in progress (example 3 links):-



hold the  key until the screen showing status of the current links appears:-

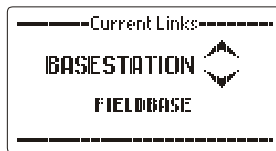

use the **Scroll keys** to select link you wish to close (example shown - a link with a station not in your ID book):-

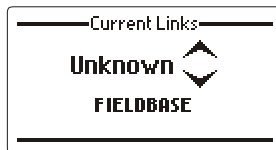

then press the  key



At this point you can either send a message, in which case go to the section "Sending an ALE text message to another station in an ALE network" or you can terminate the link:-

To terminate the link use the Scroll keys to select "Terminate Link":-

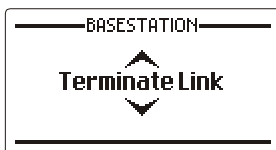

press the key

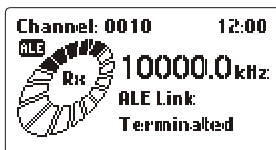

The link is now terminated and unless you are linked to more than this station then your station will return to ALE scanning or manual mode:-



Closing all ALE Links

You must be linked to close an ALE link:-





Or if more than one ALE link is in progress (example 3 links):-

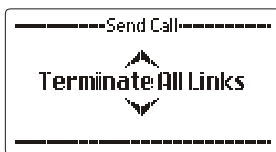

press the  key

select "Terminate All Links" with the scroll keys



then press the  key

The ALE system now terminates all open links.

Remote Station Closes the ALE Link

If the station you are linked to closes the link the following will be displayed:-

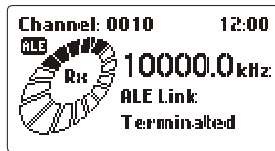

Your station will then return to ALE scanning (assuming your station was in ALE scan mode before the ALE link occurred):-



Combined ALE / Selective Call Capability

Overview

The combined ALE / Selective Call capability allows the user to receive and transmit ALE and Selcall type calls on channels which are programmed for ALE scan but also have Selcall enabled on them. This means that during ALE channel scanning the transceiver can accept incoming Selcalls. **However, this feature can only be used if the ALE scan rate is set to 2 channels per second** (set in the "2000 Series Programming Software")

To Commence Scanning

Note:- You should have selected the required scan list before you commence scanning, refer to the section "ALE scan list select" in the ALE protected menu.

Press the  key



the 2090 transceiver will now be ALE scanning and ready to accept ALE calls, receive "Soundings" and transmit "Soundings" (If "Sounding" is enabled on your transceiver)

The 2090 transceiver will also be able to decode incoming Selcalls as long as 2 channels per second is set as the ALE scan rate and Selcall is enabled on the scan channels. Selcall decoding is handled just like it is when the transceiver is in standard non-ALE scan mode.

During ALE scanning the following messages may be displayed:-



This occurs when your station receives an ALE sounding from another station in the network.

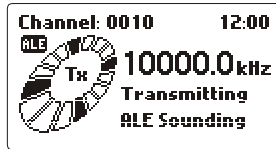

This is displayed when your station transmits a “sounding”
Note:- Your station would have to have “Sounding” enabled.

Transmitting an ALE Call

Please refer to the “Linking to Another Station in an ALE Network” section.

Receiving an ALE Call

Please refer to the “Receiving an ALE link request” section.

Receiving and Transmitting a Selective Call (Selcall)

Please refer to the “Contacting another station – using Selective Call “Selcall” and “Telcall”” section.

ALE Configuration Menus

ALE State



This feature enables or disables the ALE system

Use the **Scroll keys** to select the setting required (example “ALE Enabled”):-

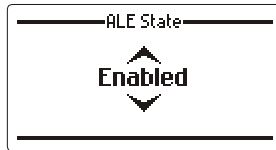

When the setting required is selected press the  key

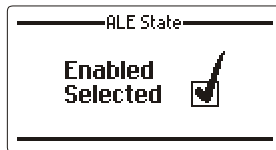

ALE Autofill

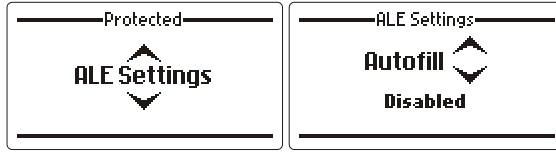

This feature enables or disables the ALE Autofill option. The Autofill option allows the 2050 transceiver to automatically add unknown stations to the ALE network. This means that whenever a new station is added to the network the network administrator does not have to individually re-configure each station in the network with the new stations ID. The Autofill queue is a first in first out queue where up to eleven new stations can be added, after this the next received unknown station will overwrite the first ID in the Autofill queue. To avoid this happening the operator must reassign the Autofill station ID alias.

Use the **Scroll keys** to select the setting required (example "Autofill Enabled"):-

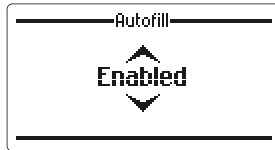

When the setting required is selected press the



key

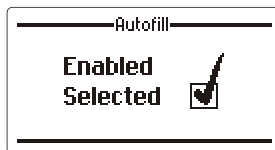

ALE Scan List

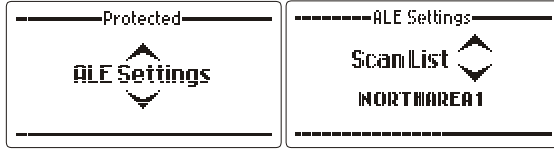

Note:- you can also enter this scan list select section by holding down the  key for more than two seconds

To select the ALE scan list required

press the  key

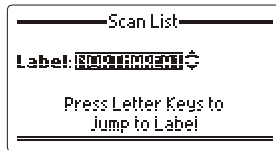

Use the **Scroll keys** or press the first letter of the scan list you want to use (example shown – “s”) to select the scan table required:-

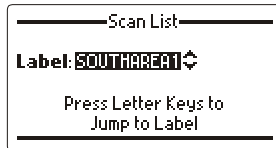

then press the  key

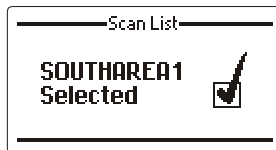



Auto Transmit

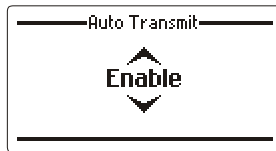

When Auto Transmit is set to "Disable" the ALE system will not respond to any calls made to this station.

Use the **Scroll keys** to select the setting required (example "Enable"):-



When the setting required is selected press the  key

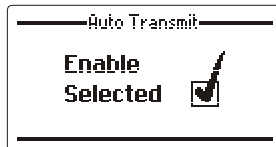

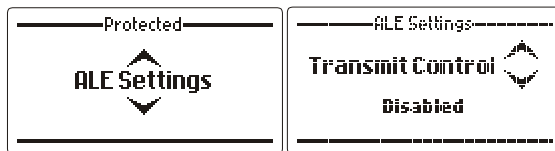

Transmit Control

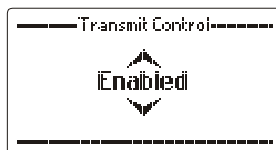

When Transmit Control is set to “Disabled” the ALE system will not be able to transmit any ALE calls, including automatic soundings and responses to incoming ALE calls.

Use the **Scroll keys** to select the setting required (example “Enabled”):-



When the setting required is selected press the  key

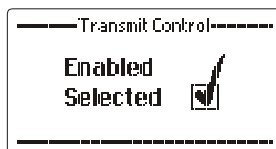



Sounding Control

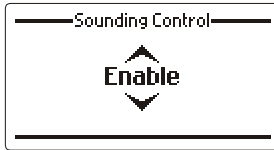

ALE operates normally both transmitting and receiving sounds when Sounding Control is set to "Enable". In some circumstances however it is desirable not to transmit soundings under any circumstances, in this case Sounding Control is set to "Disable". Sounding is limited to certain channels (pre-programmed by the ALE fill program). The ALE system will however, continue to make and respond to calls (depending on the Response Control settings).

Use the **Scroll keys** to select the setting required (example "Enable"):-



When the setting required is selected press the  key

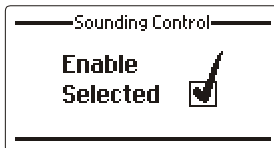

Sounding Address



Configures the self address used during an automatic sounding (Sounding Control must be set to Global On). If sounding control = individual preset basis, the address used is dependant on the active channel.



Use the **Scroll keys** to select the setting required (example "FIELDBASE2"):-



When the setting required is selected press the **ENTER** key

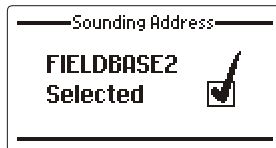

Link Quality Analysis (LQA) Exchange



This option enables or disables the exchange of LQA information with other stations

Use the **Scroll keys** to select the setting required (example "Enabled");-

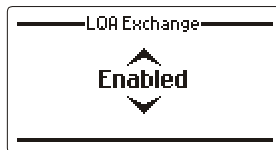

When the setting required is selected press the



key

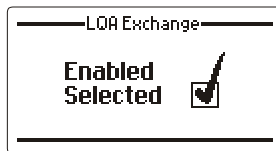

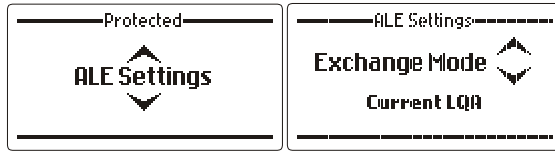

Link Quality Analysis (LQA) Exchange Mode

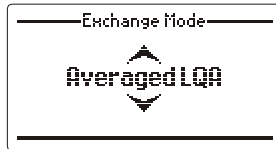

This option sets the source of the LQA reading sent to the other station, it can be set to “Current LQA” which is a reading taken during the ALE burst just received or it can be set to “Averaged LQA” which uses the long term averaged value taken from memory.

Use the **Scroll keys** to select the decay time or disable (example “Averaged LQA”):-



When the setting required is selected press the  key

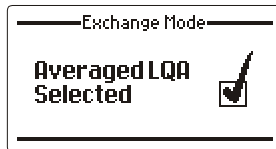

Link Quality Analysis (LQA) Averaging



This option sets the method used to update an existing link quality value stored in ALE processor memory when the new link quality value is worse than the stored value.

The option can be set to either replace the old values with the new values or replace the old values with different weighted averages of the old values and new readings.

Averaging reduces the effect that one bad reading might otherwise have on a perfect channel. If a new reading is better than an old value, the old value is replaced by the reading. There are 4 different averaging formulas available:-

- No averaging, replace the old values with new values
- $(old+new)/2$
- $((3*old)+new)/4$
- $((7*old)+new)/8$

Use the **Scroll keys** to select the LQA averaging value required (example " $((7*old)+new)/8$ ":-



When the setting required is selected press the  key

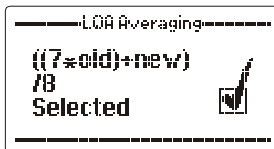

Link Quality Analysis (LQA) Decay Rate





This option sets the artificial decay rate for the link quality information that is stored in the link quality table within the ALE processor.

Switching the sounding off and setting a decay rate of two hours would result in the recording of a perfect channel (100% channel quality) decaying to an unusable channel (0% channel quality) over a period of two hours.

The decay rate can be disabled, set to 1,2,4,8,24 and 48 hours.

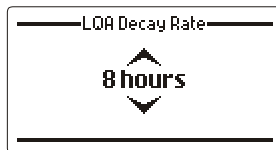
Use the **Scroll keys** to select the decay time or disable (example "8 hours"):-



When the setting required is selected press the  key

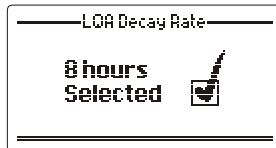

Threshold Test

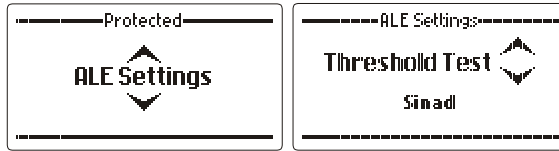

Used to select which type of threshold test is used to determine what quality ALE channel is acceptable for communication. Either "Sinad", "BER", "Both" or "None" can be selected.

Use the **Scroll keys** to select the test required (example "BER"):-



press the  key

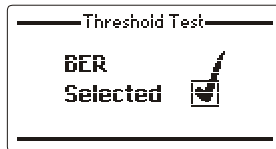

SINAD Threshold

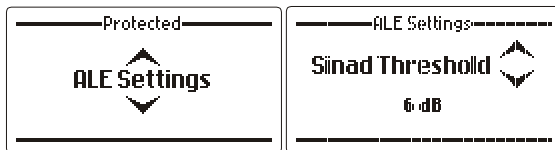

This option sets the SINAD threshold at which an ALE channel is considered usable.

This can be set to between 0 and 30dB.

press the  key

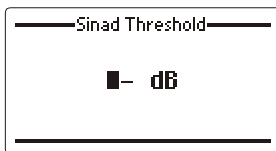

using the numeric keys enter the SINAD threshold required (example "12dB"):-



then press the  key

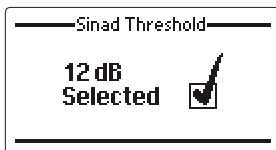

BER Threshold



This option selects the BER threshold at which an ALE channel is considered usable. If the required BER is not reached in the reply from the remote station the link establishment process is rejected. Depending on the retry setting the link establishment would continue on another link.

It can be set between 0-30, selecting 30 effectively means that all links are allowed

press the  key

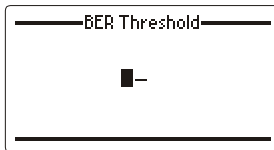

using the numeric keys enter the BER threshold required (example "7"):-



then press the  key

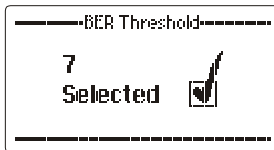

ALE Fill Mode

The ALE is configured with its entire network data using the Barrett PC based ALE fill program. Refer to the Barrett 2050 PC based programming software that contains the ALE fill program for details.

Programming Functions

The Barrett 2090 transceiver can be programmed in three ways:-

Using the software supplied with the programming kit (P/N 2090-01-30), loaded on a PC, and transferring information to the 2090 by RS-232 through the auxiliary connector.

By direct key entry through the front panel

Note:- This facility may not be available if the network administrator has barred the function during programming using a PC.

By cloning information from another transceiver, through the auxiliary connector using a cloning cable Barrett P/N BCA204020.

Programming Using the Programming Software

The programming software should be loaded onto PC using the instructions supplied with the package.

Transceiver configuration packs are uploaded and downloaded to the 2090 transceiver via the auxiliary socket on the 2090 transceiver.

Programming Using the Supplied Barrett Cable

To program the transceiver using the RS-232 port of your PC or Laptop plug one end of the programming cable supplied into the PC or laptops serial port. The other end should be plugged into the auxiliary socket. The PC or laptop should have the Barrett 2000 series programming software running and the 2090 should be switched on. Programming functions can now commence.

Programming a Channel from the Front Panel

Note:- To program a channel from the front panel it is necessary to have this function enabled.

To enter the programming mode first select the channel you want to program then press the  key:-

Transmit and Receive Frequencies

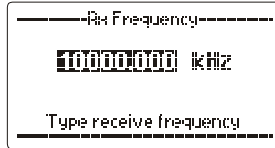

Use the numeric keypad to enter the receive frequency

then press the  or  key

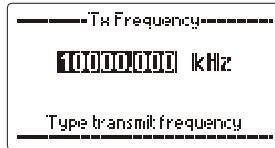

Use the numeric keypad to enter the transmit frequency

then press the  or  key

Channel Use Labels

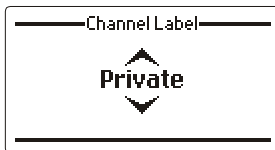

Use the Scroll keys to select the required channel label

Note:- channel labels can be entered in the "General" section of the protected menu.

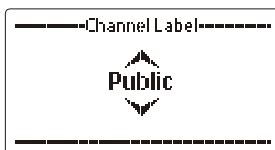

then press the  or  key

Operating Mode

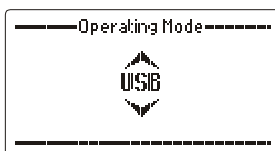

Use the Scroll keys to select the required operating mode, USB, LSB, AM, CW or AFSK

then press the  or  key

Note:- If the 500 Hz or narrow filter hardware option is enabled this filter is automatically selected in CW mode and AFSK mode

Transmitter Power Setting

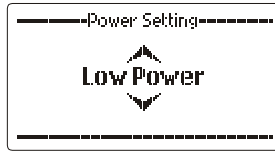

Use the Scroll keys to select the required output power – high, medium or low power.



then press the  or  key

Selcall Format

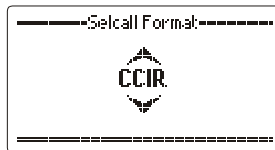
Each channel can be programmed for one Selcall format, for a description of the formats available, refer to the beginning of this manual.



Use the Scroll keys to select the required Selcall format

then press the  or  key

This last key press displays the following screen indicating the channel programming is complete:-



The channel program sequence can be aborted at any stage in the programming sequence by pressing the  key after which the following is displayed:-

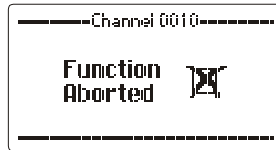

Cloning (Programming) from Another Transceiver

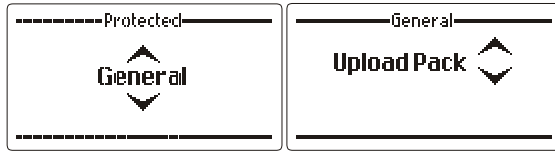



Note:- Use the transceiver you want to **send the configuration from** for the following steps

This feature is used to send a copy of the configuration of one 2090 transceiver or 2090 transceiver fitted in the manpack adaptor to another using a cable (BCA204020) connecting both transceivers together via their auxiliary connectors using the RS-232 connection.

Before uploading commences it is necessary to enter the Selcall IDs of the transceiver that will be loaded.

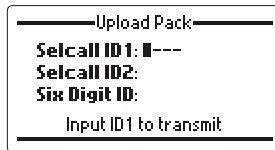
press the  key



Using the numeric keypad enter Self ID 1 and press the  key

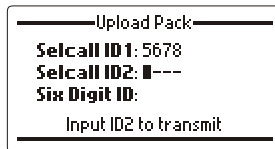

Using the numeric keypad enter Self ID 2 and press the  key

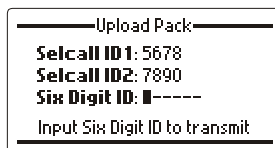

Using the numeric keypad enter Six digit ID and press the



key

Upload Pack
Selcall ID1: 1234
Selcall ID2: 7890
Six Digit ID: 123456
Press Enter to Upload

then press the



key to proceed with cloning.

Manpack Operation

Power Systems

The Barrett 2090 transceiver uses a removable 10Ah Lithium Ion battery cartridge. This cartridge contains the battery and the battery management system. It has a connector that is used for charging and operating the 2090 when connected to the 2090 or charging the battery when not connected to the 2090.

A DC input between 20VDC and 30VDC is required, allowing operation and charging from 24V vehicle sources, 24V solar panels and 24V hand crank generators. A separate Universal AC/DC input power adaptor is available to charge and operate the manpack when mains voltages are available between 100-254 VAC or DC voltage between 11-18VDC are available from sources such as 12V vehicles sources.

With the battery cartridge fitted the transceiver can be operated and the battery cartridge charged when a DC input of between 20 VDC and 30 VDC is supplied to the unit.

Universal AC/DC Power Adaptor P/N 2090-03-01

For operation from a mains voltage between 100-254VAC or from 12VDC sources such as available in a vehicle:-

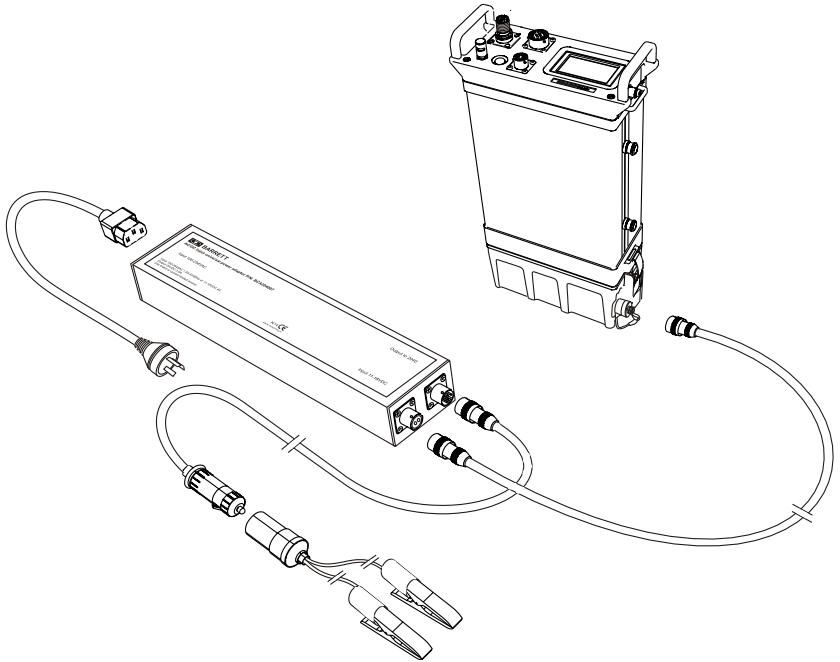
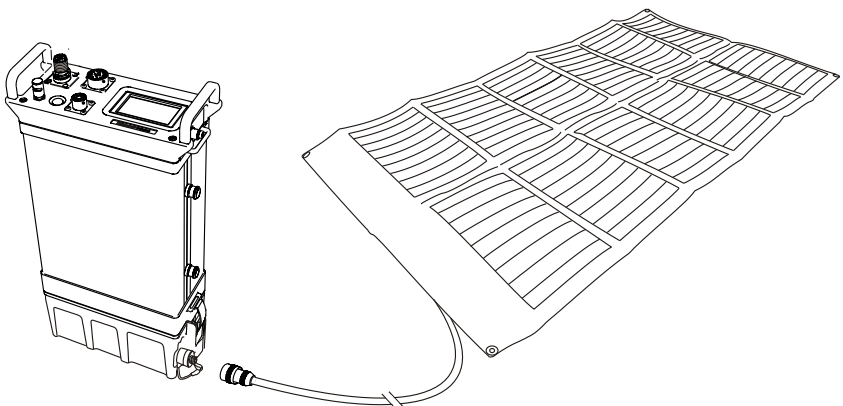
**Rapid Deployment Solar Panel P/N BCA209010**

Rapid Deployment Hand Crank Generator P/N 2090-03-04

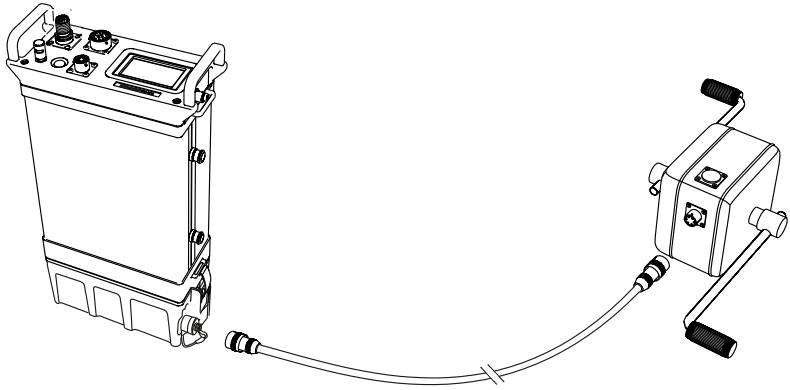

Charging a 10Ah Lithium Ion Battery Cartridge Outside the Manpack

The 2090 battery cartridge can be charged outside the manpack using the AC/DC input universal power adaptor unit or directly from a 24V solar panel or a 24V hand crank generator configured as shown in the following diagrams:-

Universal AC/DC Power Adaptor P/N 2090-03-01

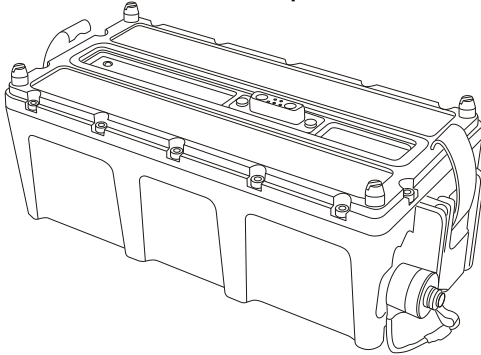

For operation from a mains voltage between 100-254VAC or from 12VDC sources such as available in a vehicle:-

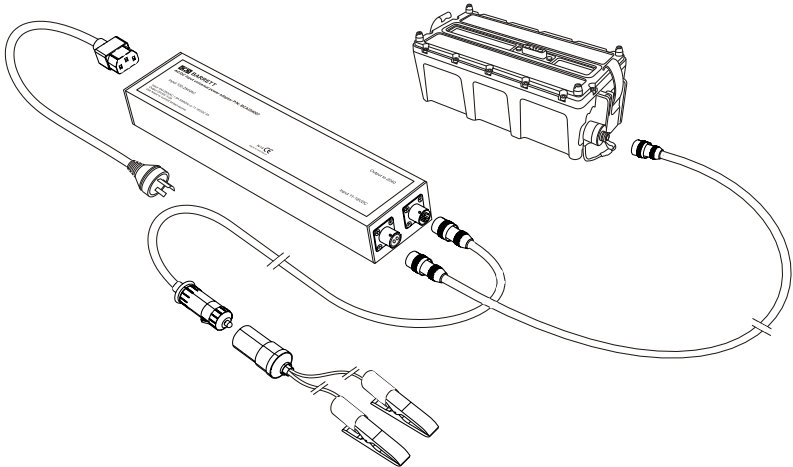

Rapid Deployment Solar Panel P/N BCA209010

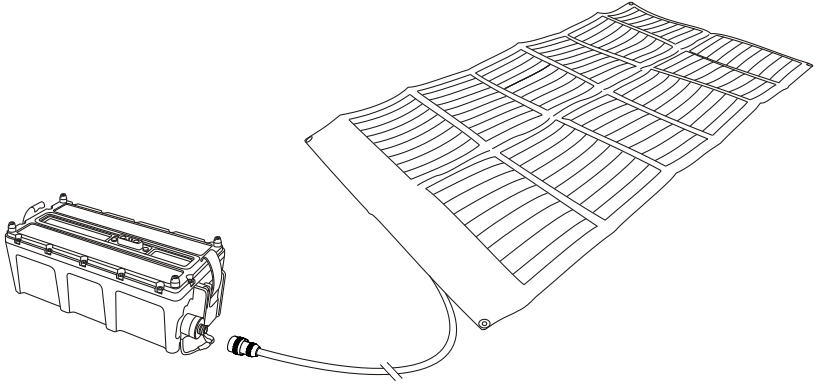

Rapid Deployment Hand Crank Generator P/N 2090-03-04

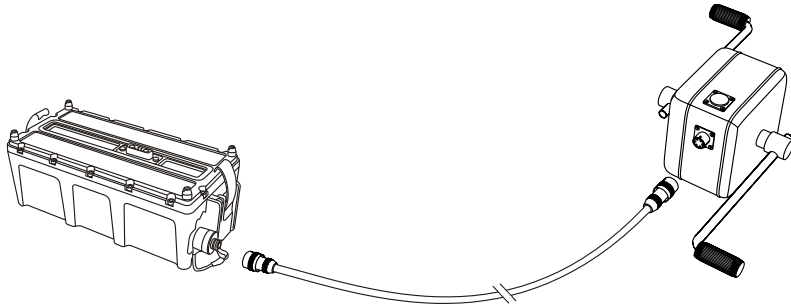

Battery Charge Indicator when Charging the 2090

When the charging source is connected to the 2090 and the transceiver is switched on, the battery icon between the channel number and the time shows the progress of the charge process:-

The battery icon with a moving line running from left to right indicates that the battery is charging, once the charger is removed the battery icon represents battery capacity available:-

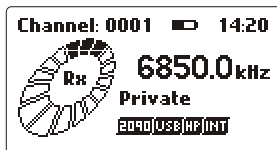

The battery icon stationary and filled "black" indicates that the battery is charged and the charger is now trickle charging:-

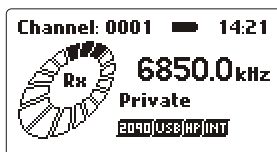

When the 2090 is in charge mode the estimated charge time left is displayed in the Identification menu.

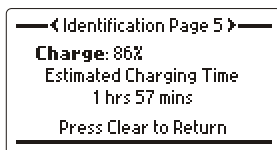

Operation in the Manpack Configuration

Using the Display / Handset Extender Interface (P/N BCA209013)

The 2090 manpack LCD unit can be removed from the manpack itself and placed into the LCD unit pouch located on the manpack bag using the extension kit supplied. Please see below on how to use the extension kit.

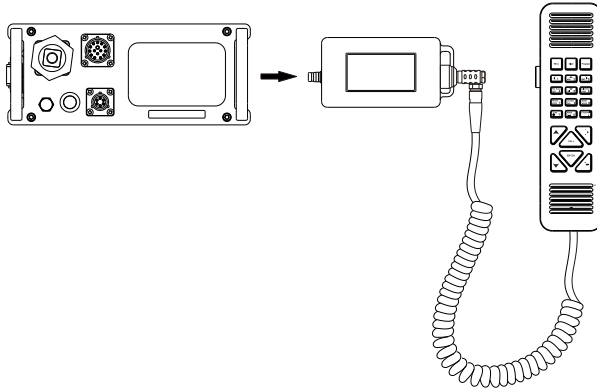

Step 1: Pull out the LCD unit from the manpack.



Step 2: Get extender cable and plug one end into LCD blanking unit.

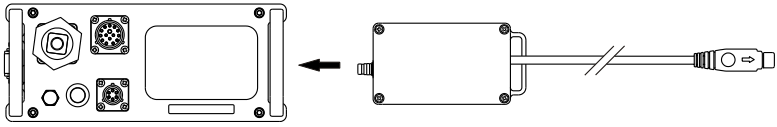

Step 3: Push LCD blanking (metal face side up) unit into the manpack.

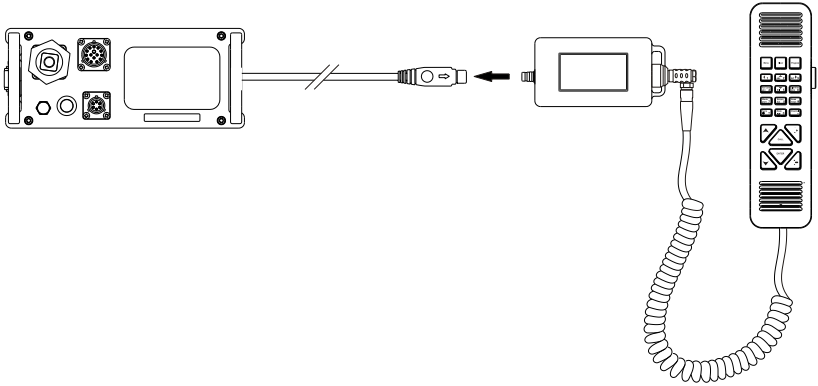

Step 4: Connect LCD unit to the unconnected end of the extender cable.

Manpack Operation Using the Automatic Antenna Tuner

The 2090 manpack can be used with the 10 metre throw over long-wire provided or the optional 3 metre collapsible whip.

Note:- Either the whip or the long-wire can be used but not both together.

Using the Collapsible 3 m Whip (P/N 2090-02-07)

The gooseneck should be fitted to the whip antenna stud and the whip unfolded to its maximum height. If using the Barrett manpack while walking in the backpack configuration it is suggested that while in receive standby mode the collapsible antenna be only extended to half height and secured using the Velcro tab. **When a call is received extend the antenna to full height before transmission.**

Note:- When using an un-tuned antenna such as the whip or the long-wire the section “**Antenna Select**” in the standard menu should be used to enable the automatic tuner i.e. select “Whip/Long-wire” operation. When this is selected the in-built tuner automatically tunes the whip or long-wire whenever the unit transmits after a channel change.

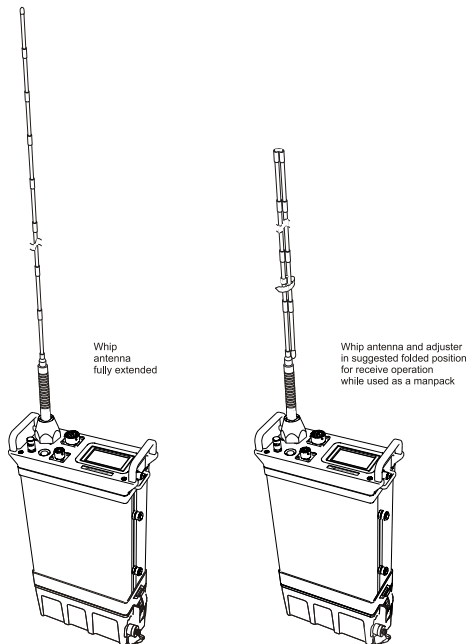

Using the Emergency Long Wire Antenna (P/N 2090-02-06)

The long-wire antenna should be unfurled and the end away from the manpack transceiver should be attached to any structure available and as high as possible.

Note:- When using an un-tuned antenna such as the whip or the long-wire the section “**Antenna Select**” in the standard menu should be used to enable the automatic tuner i.e. select “Whip/Long-wire” operation. When this is selected the in-built tuner automatically tunes the whip or long-wire whenever the unit transmits after a channel change.

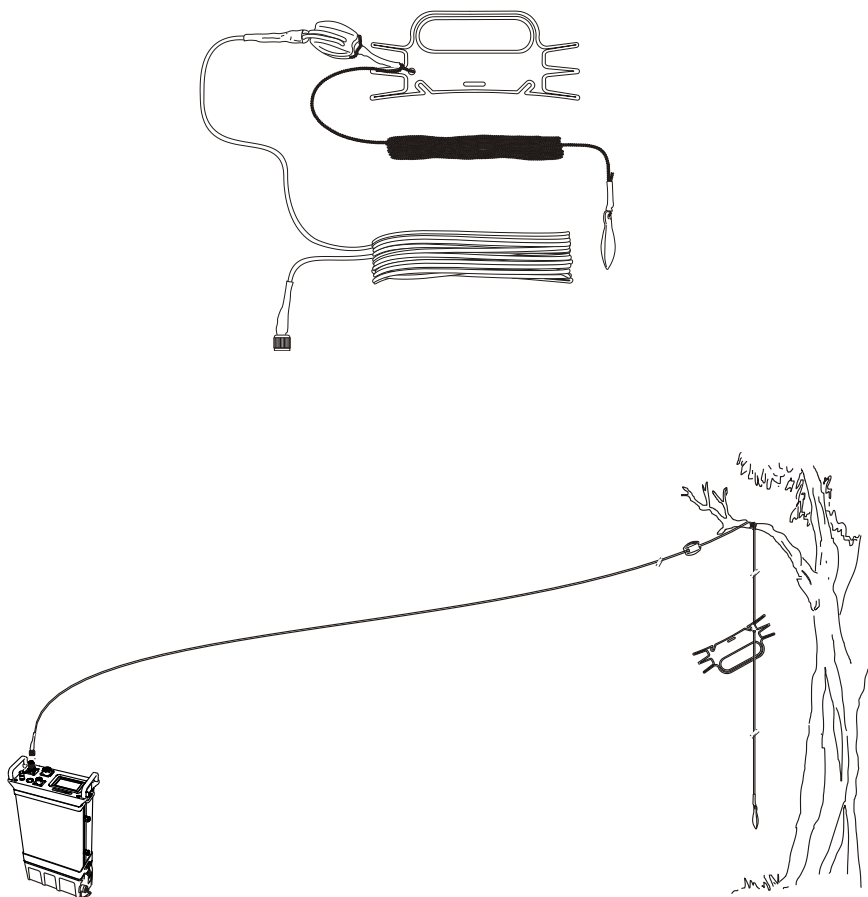

Using the Counterpoise Earth Kit - multi-wire (P/N 2090-02-08)

When using either a whip or the long-wire antenna efficiency can be increased by the use of the counterpoise supplied. This is connected to the 2090 via the BNC connector connected to the counterpoise. The three radials should be spread out on the ground as indicated in the diagram below:-

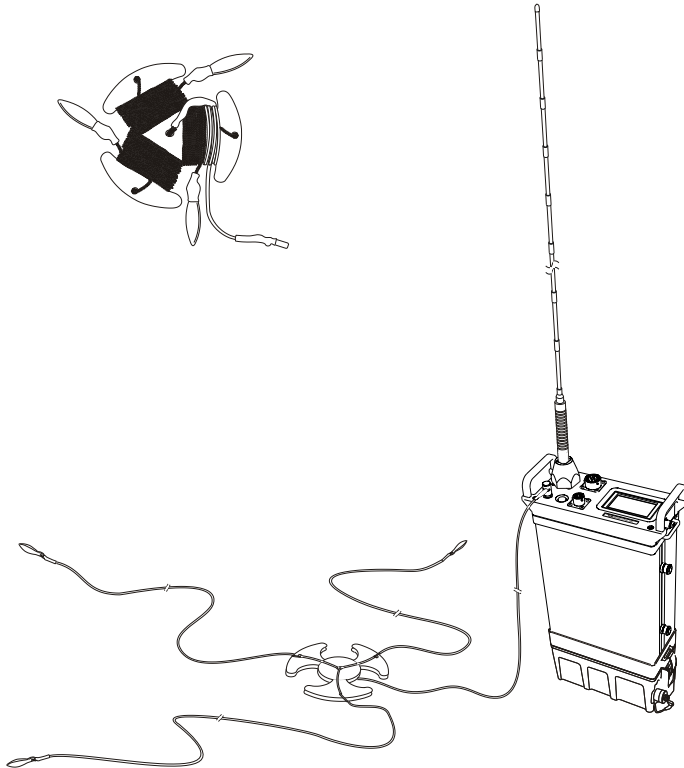

Operation of the 2090 Manpack in Temporary Base Stations

For temporary base station operation, the Barrett 2090 can be operated using either a broadband antenna **Barrett P/N BCA209006** or a tunable wire dipole, **Barrett P/N BCA209007**.

Rapid Deployment Broadband Dipole Antenna - 40 W (2090-02-03)

The Broadband Dipole Antenna is a dipole antenna with loading to allow broadband operation. For operation, each side of the antenna is unwound to its full length. Throwing cords are provided that can be used to elevate the antenna or tie it to ground for an inverted V configuration. The antenna will handle continuous data and CW transmission with a Barrett 30w manpack radio. Only low duty cycle voice operation is supported for operation with 100w transmitters. The antenna can be used in a number of configurations, depending on structures available for elevation.

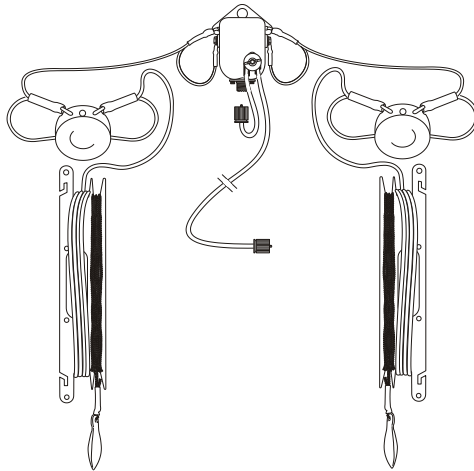

Rapid Deployment Broadband Dipole Antenna Configurations

Horizontal Dipole

The horizontal dipole has maximum gain on the broadsides of the antenna and reduced gain along the axis. Height above ground affects radiation angle. Lower heights give higher angle radiation, better for NVIS (short distance). Higher heights give lower radiation angle, better for long distance communication.

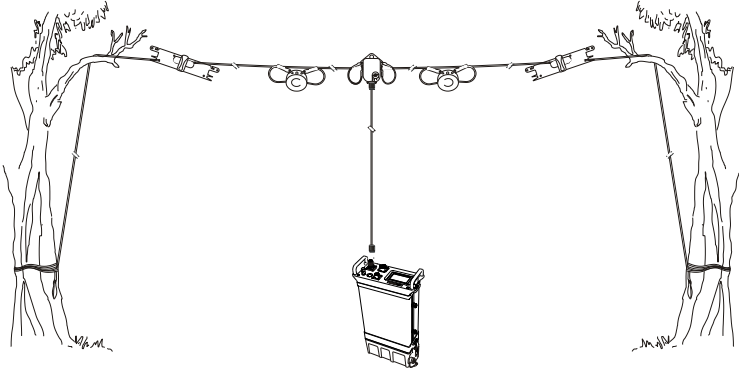

Inverted V

The inverted-V has a more omni-directional pattern than the Horizontal Dipole, with lower maximum gain. The ends of the antenna should be at least 0.5m above ground. Suitable mainly for NVIS and medium distance.

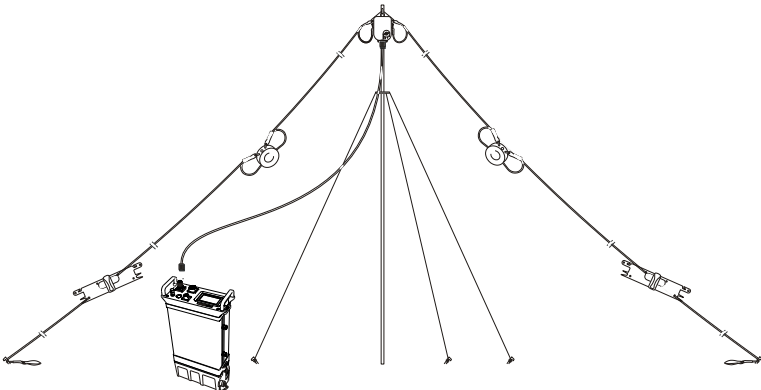

Sloping Dipole

Radiation with the Sloping Dipole becomes more directional, with increased gain in the direction of the lower end of the antenna, and reduced gain towards the higher end.

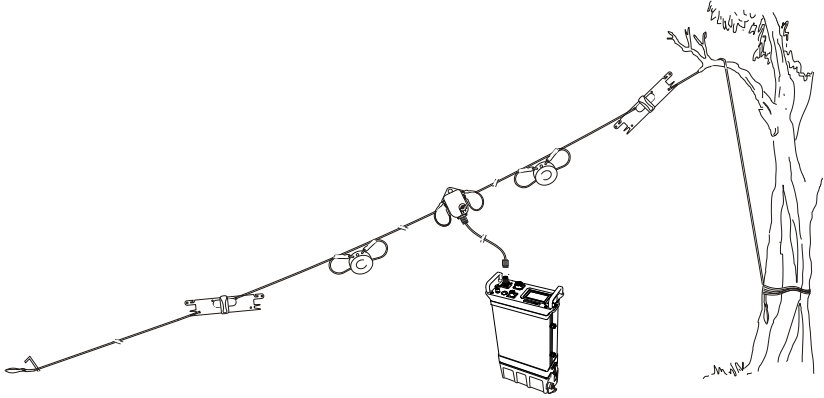

Inverted U

The inverted U has a radiation pattern between that of horizontal dipole and inverted V. For optimum performance, the radiating elements should be fully unwound, and should not touch the ground. Suitable for NVIS to medium distance. Longer distance performance will be enhanced by erecting the antenna at a height of 10m or more.

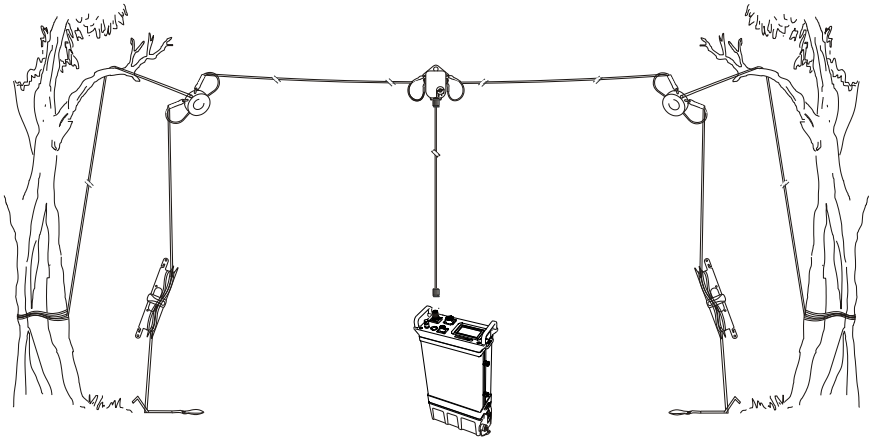

Rapid Deployment Dipole Antenna - 40 W (2090-02-01)

The Rapid deployment tunable wire dipole is a tuned antenna with frequency labels to indicate tuned lengths. For operation, each side of the antenna is unwound to the tuned length for the frequency required. For operation at a labelled frequency, the label should be level with the end of the winder as shown in the picture below. Lengths for intermediate frequencies should be estimated and tied off appropriately. The remaining wire remains on the winder. The throwing cord can then be used to elevate the antenna. The antenna will handle 100W continuous data and CW transmission. The antenna can be used in a number of configurations, depending on structures available for elevation.

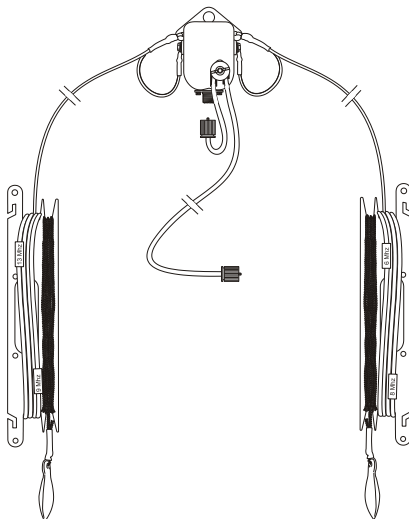

Rapid Deployment Dipole Antenna Configurations

Horizontal Dipole

The horizontal dipole has maximum gain on the broadsides of the antenna, and reduced gain along the axis. Height above ground affects radiation angle. Lower heights give higher angle radiation, better for NVIS (short distance). Higher heights give lower radiation angle, better for long distance communication.

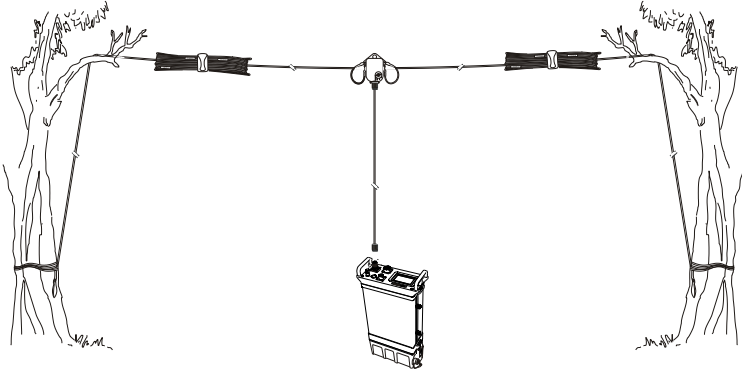

Inverted V

The inverted-V has a more omni-directional pattern than the Horizontal Dipole, with lower maximum gain. The ends of the antenna should be at least 1m above ground. Suitable mainly for NVIS and medium distance.

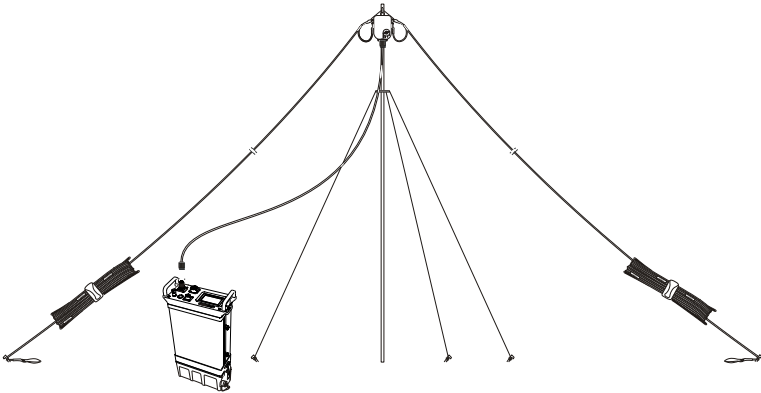

Sloping Dipole

Radiation with the Sloping Dipole becomes somewhat asymmetrical, with increased gain in the direction of the lower end of the antenna, and reduced gain towards the higher end.

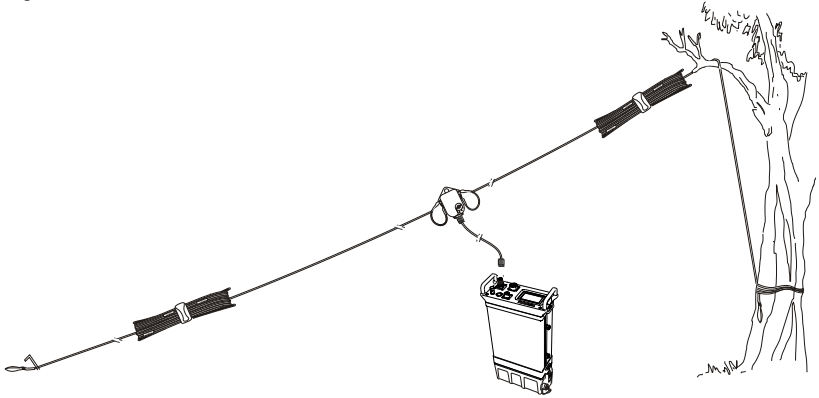

Single Ended

For rapid deployment, with reduced but still acceptable efficiency, the antenna can be operated single ended. In this configuration, one side of the antenna (labelled "antenna") is unwound to the desired frequency and tied to an elevated structure. The central balun should be located close to the ground, and the remaining side of the antenna ("earth") partly unwound (5 to 10m) and stretched out on the ground below the radiating element.

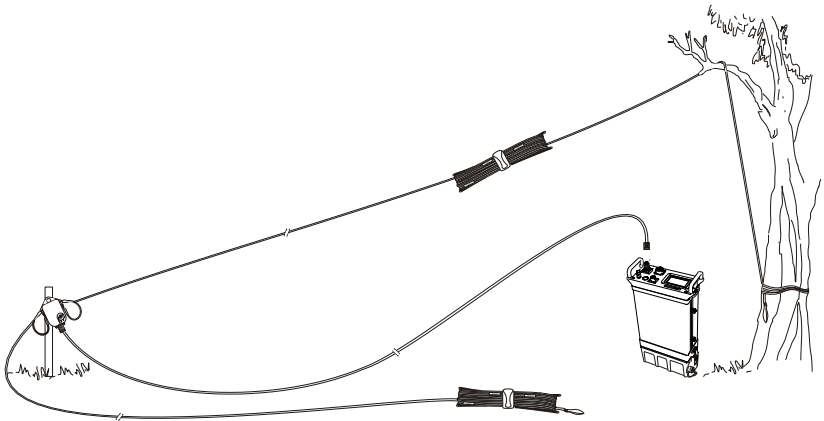

Connectors

Auxiliary Socket

15 pin waterproof panel mounted socket

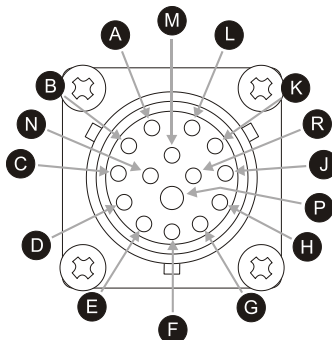

Pin	Name	Description of function	Level
A	+13V8 Fused	Fused 13.8VDC output	+13.8VDC
B	Bal Audio Out 1	Balanced audio out 1	600 Ω -6dBm to +9dBm
C	Bal Audio Out 2	Balanced audio out 2	600 Ω -6dBm to +9dBm
D	Bal Audio Out 1	Balanced audio in 1	600 Ω -24dBm to 0dBm
E	Bal Audio Out 2	Balanced audio in 2	600 Ω -24dBm to 0dBm
F	Aux PTT	PTT in	Active low 0V
G	RS-232 Tx	RS-232 Tx data	True RS-232 levels
H	RS-232 Rx	RS-232 Rx data	True RS-232 levels
J	Scan Stop	Scan stop input	Active low 0V
K	PTT Out	PTT output to external equipment	Active low 0V
L	Aux Dig Out 2	Auxiliary digital output (future use)	Active low 0V
M	External MICH	Balanced Microphone input high	
N	Speaker	Loudspeaker output	0-10V
P	Gnd	Ground	Ground 0V
R	External MICL	Balanced Microphone input low	

ESU/CW Socket

6 pin waterproof panel mounted socket

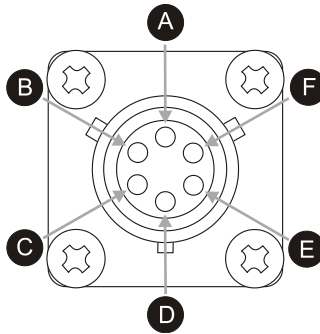

Pin	Name	Description of function	Level
A	N/C	N/C	TTL
B	NMEA +	NMEA data input	+5VDC
C	+5	+5V	+5VDC
D	CW key	CW key input	Active low 0V
E	Gnd	Ground	Ground 0V
F	N/C	Not connected	

Handset Socket**6 pin waterproof panel mounted socket**

Pin	Name	Description of function	Level
A	MICL	Balanced Microphone input low	
B	MICH	Balanced Microphone input high	
C	PTT	PTT input	Active low 0V
D	Speaker	Loudspeaker output	0-10V
E	Aud UnBal	Unbalanced audio in	
F	Gnd	Ground	Ground 0V

Power Socket (on Battery Pack)**4 pin waterproof panel mounted socket**

Pin	Name	Description of function	Level
A	+VIn	External supply input – positive	+22 to 28 VDC
B	+VIn	External supply input – positive	+22 to 28 VDC
C	Gnd	External supply input – negative	-22 to 28 VDC
D	Gnd	External supply input – negative	-22 to 28 VDC

GPS Receiver/Antenna Module P/N 2090-01-22

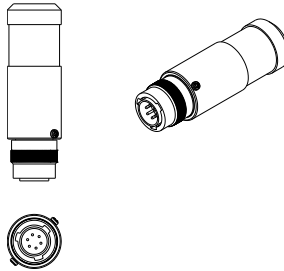

To provide positional information to the Barrett 2090 the GPS Receiver/Antenna Module P/N 2090-01-22 is plugged into the ESU/CW Socket on the front of the Barrett 2090 transceiver.

Note:-Should the Barrett 2090 be operated inside a bunker or building an 8 meter GPS extension cable P/N 2090-01-23 is available to mount this module outside in view of the satellites.

Encryption Synchronisation Unit
P/N: 2090-01-24

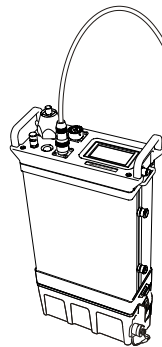
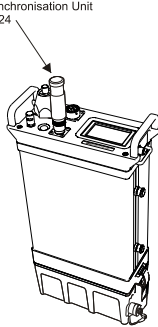

Encryption Synchronisation Unit
P/N: 2090-01-24

Encryption Synchronisation Unit
8 metre extension
P/N: 2090-01-23

Overview of HF Operation

HF (High Frequency) is the radio spectrum with frequencies between 1.6 and 30 MHz. Within this radio spectrum an efficient form of transmitter modulation, SSB (Single Side Band), is used. This, combined with the use of the ionosphere - a layer of ionisation gases that resides between 100 and 700km above the earth's surface, provides efficient, cost effective communications over short, medium and long distances - without the need for expensive re-transmission devices, such as the VHF or UHF repeaters or satellites, all of which have on going operational costs and a reliance on a physical infrastructure.

In many remote areas, HF/SSB is the only form of communication possible.

HF Propagation

When HF/SSB radio waves are generated by the transceiver there are usually two components:-

- The ground-wave, which travels directly from the transmitting antenna to the receiving antenna following the contours of the earth.
- The sky-wave, which travels upward and at an angle from the antenna, until it reaches the ionosphere (an ionised layer high above the earth's surface), is refracted back down to earth, to the receiving antenna.

Generally speaking, ground-wave is used to communicate over shorter distances usually less than 50km. Because ground-wave follows the contours of the earth, it is affected by the type of terrain it passes over. Ground wave is rapidly reduced in level when it passes over heavily forested areas or mountainous terrain.

Sky-wave is used to communicate reliably over medium to long distances up to 3,000km. Whilst the nature of sky-wave propagation means it is not affected by the type of terrain as in ground waves it is affected by factors involving the ionosphere as described below.

Radio Wave Propagation Illustrated

The following illustrations show the characteristics of ground-wave and sky-wave propagation during day and night time. In each illustration the height of the ionosphere above the ground is shown.

In both illustrations Station A communicates with Stations B, C and D. Propagation from Station A to B is by ground-wave. The diagrams illustrate that the ground wave is not affected by the time of day and the height of the ionosphere above the ground.

Propagation from Station A to C and D, however, is by sky-wave and as the diagrams illustrate the sky wave is significantly affected by the time of day and the height of the ionosphere above the ground.

Under each diagram there are recommended working frequencies listed. Please note that these will vary according to time of year and other factors. They are intended only as a guide and are subject to change.

Day

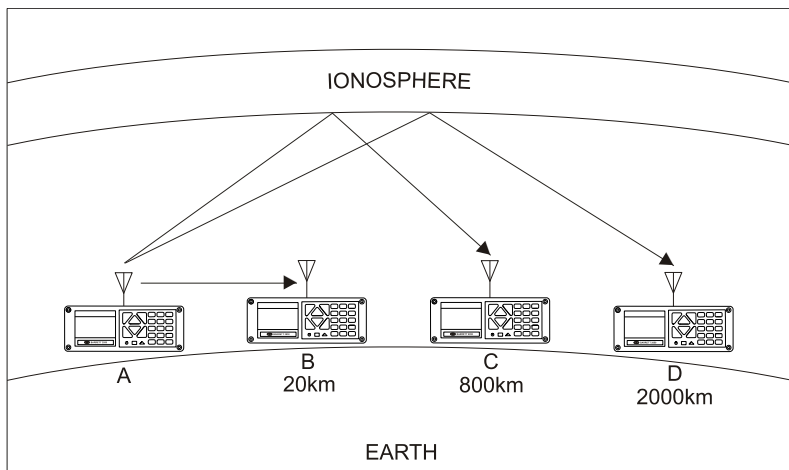

The sun is higher, the ionosphere is higher, the best frequency to use is higher

- A to B - Possible optimum working frequency is 3 MHz
- A to C - Possible optimum working frequency is between 7 - 9 MHz
- A to D - Possible optimum working frequency is between 13-16 MHz

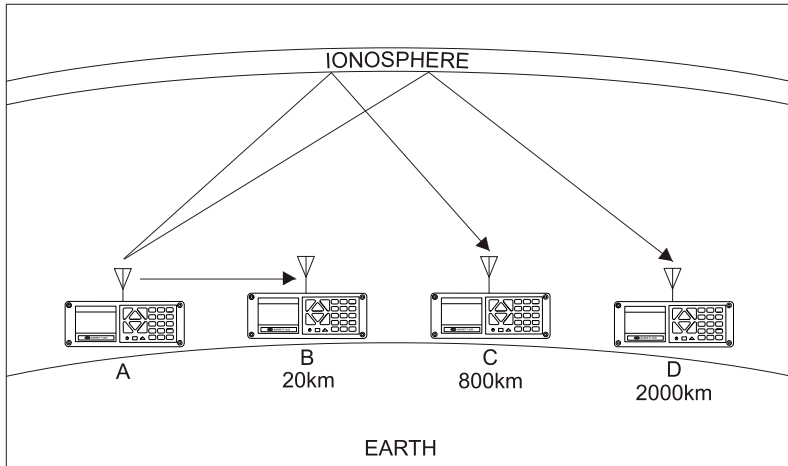
Night

The sun is lower, ionosphere is lower, best frequency to use is lower

A to B - Possible optimum working frequency is 3 MHz

A to C - Possible optimum working frequency is between 5 - 7 MHz

A to D - Possible optimum working frequency is between 9 - 12 MHz

Factors Which Affect HF/SSB Communications

There are a number of different factors which will affect the success of your communications via HF/SSB radio. These are outlined below:-

Frequency Selection

Frequency selection is perhaps the most important factor that will determine the success of your HF/SSB communications.

Generally speaking the greater the distance over which you want to communicate, the higher the frequency you should use.

Beacon Call, a Selcall (Selective Call) function built into the Barrett 950 transceiver, makes finding the correct frequency to use easy. Beacon Call is based on the network transceivers all having a selection of frequencies that will accommodate most ionospheric conditions. When in standby the network transceivers scan these frequencies waiting for a call (Selcall or Beacon Call) from another transceiver. The transceiver wishing to check for the best frequency to operate on sends a Beacon Call to the station he wishes to contact. If his call to the other station is successful he will hear a revertive call from the station he is calling, indicating the channel he selected was suitable for the ionospheric conditions prevailing. If he does not hear this revertive call or it is very weak, he tries on another channel until a revertive call of satisfactory signal strength is heard.

(Refer to Selcall (Selective Call) section of this manual for full details on Beacon Call operation.)

Time of Day

As a rule, the higher the sun, the higher the frequency that should be used. This means that you will generally use a low frequency to communicate early morning, late afternoon and evening, but you will use a higher frequency to cover the same distance during times when the sun is high in the sky (e.g. midday). You will need to observe the above rule carefully if your transceiver has a limited number of frequencies programmed into it, as you may only be able to communicate effectively at certain times of the day.

Weather Conditions

Certain weather conditions will also affect HF/SSB communications. Stormy conditions will increase the background noise as a result of 'static' caused by lightning. This background noise could rise to a level that will blank out the signals you are trying to receive.

Man-made Electrical Interference

Interference of an electrical nature can be caused by overhanging power lines, high power generators, air-conditioners, thermostats, refrigerators and vehicle engines, when in close proximity to your antenna. The result of such interference may cause a continuous or intermittent increase in the level of background noise.

System Configuration and Installation

The method in which your system is configured and installed will also affect the success of your HF/SSB communications. Your choice of antenna system and power supply is critical. Correct installation is also extremely important. An HF/SSB transceiver is generally installed using different rules to those used to install VHF or UHF transceivers. Failure to correctly install an HF/SSB system will greatly affect the communications quality you will obtain. Refer to the installation section of this manual for details.

Your local Barrett representative will be able to assist with your system configuration and/or installation.

Special Note - HF Communications Compared with VHF or UHF Short Distance Communications

Communications on any HF/SSB transceiver will sound different to that on a VHF (Very High Frequency) radio or UHF (Ultra High Frequency) radio or telephone. This is because of the nature of HF propagation and the modulation methods used. On HF/SSB transceivers there will always be background noise evident behind the signal you are receiving and this will increase when there is electrical interference or thunderstorm activity in the area.

Limited 3 Year Warranty

Barrett Communications Pty Ltd provides a maximum three year warranty on all equipment it manufactures which is to be used expressly for high frequency, single sideband radio communications. This warranty covers faults arising from defects in design, workmanship or materials. Please note that this warranty does not cover batteries.

As the Barrett 2090 HF Radio System is fully immersible to 1 metre, it is imperative that the transceiver is not opened. The warranty for the 2090 will be void if the transceiver is opened by anyone other than Barrett Communications Pty Ltd staff

Should any fault due to bad design, workmanship or materials be proven at any time within the warranty period, the company will rectify such fault free of charge providing the equipment is returned freight paid to Barrett Communications Pty Ltd or to an authorised service centre. The warranty period for all products is twelve months after shipment from the factory or an authorised Barrett agent or dealer. In the event that the end user completes and lodges warranty registration documents within three months of receipt of the shipment from the factory or an authorised Barrett agent or dealer, the warranty period shall be extended by an extra twenty four months giving a total warranty period of three years.

This warranty shall not cover any abuse, accident, improper installation, connection, adjustment or use other than in accordance with the instructions issued by the company.

In addition, this warranty shall not cover the distance which transceiver products will operate over or quality of transmission or reception as a result of unfavourable environmental conditions. Nor shall this warranty cover the quality of transmission and reception of transceivers mounted in vehicles or vessels that have not been sufficiently electrically suppressed.

Subject to the matters set out in this warranty, no liability, expressed or implied is accepted for any consequential loss, damage or injury arising as a result of a fault in the equipment and, all expressed or implied warranties as to quality or fitness for any purpose are hereby excluded.

This warranty does not extend to products supplied by the company which are not designed or manufactured by it. Barrett Communications Pty Ltd will however make every endeavour to ensure that the purchaser receives full benefit on any warranty given by the manufacturer.

This warranty is restricted to the original purchaser. Where the original purchaser is a reseller who has purchased for the purpose of resale, warranty shall be extended to the reseller's customer.

Warranty Registration and Customer Support

Thank you for purchasing Barrett HF communications products.

The standard and automatic warranty on Barrett products is one year. By completing the registration form on the next page and sending it to us by mail, fax or email, this warranty will be extended to a total of three years at no extra cost.

By registering for the extended warranty period Barrett Communications will also provide the following services:-

Your contact details will be registered against the serial numbers of the equipment.

Barrett Communications will keep you informed of any developments relating to this equipment.

Barrett Communications will provide you with direct access to a support telephone contact line manned from 0000hrs GMT to 1600 Hrs GMT, 7 days a week.

The registration forms can be returned by mail, (no postage stamp required in Australia) or by facsimile (08) 9418 6757 (International + (618) 9418 6757).

If you have access to the Internet you can use the warranty registration page in the support section of our website to register your warranty form. Please go to www.barrettcommunications.com.au

We will mail or email you if you have registered via the Internet details of your support package within 7 days of receiving your completed registration form.

Barrett Communications is proud of its reputation for support of its customers. This registration process has been introduced so that we may continue to improve our level of support to you.